

Bulletin Officiel de la Propriété Industrielle (BOPI)

Brevets d'inventions

PUBLICATION

N° 07 BR / 2015

du 28 Mars 2016

Organisation
Africaine de la
Propriété
Intellectuelle



SOMMAIRE

TITRE	PAGES
PREMIERE PARTIE : GENERALITES	2
Extrait de la norme ST3 de l'OMPI utilisée pour la représentation des pays et organisations internationales	3
Extrait de la norme ST9 de l'OMPI utilisée en matière de documentation des Brevets d'Invention et des Modèles d'Utilité	6
Codes utilisés en matière d'inscriptions dans les registres spéciaux des Brevets d'Invention et des Modèles d'Utilité	6
Clarification du règlement relatif à l'extension des droits suite à une nouvelle adhésion à l'Accord de Bangui	7
Adresses utiles	8
DEUXIEME PARTIE : BREVETS D'INVENTION	9
Repertoire numérique du N° 17116 au N° 17165	10
Repertoire suivant la C.I.B	34
Repertoire des noms	36

**PREMIERE PARTIE
GENERALITES**

Extrait de la norme ST.3 de l'OMPI

Code normalisé à deux lettres recommandé pour la représentation des pays ainsi que d'autres entités et des organisations internationales délivrant ou enregistrant des titres de propriété industrielle.

Afghanistan	AF	Cook, Îles	CK
Afrique du Sud	ZA	Corée (République de Corée)	KR
Albanie	AL	Corée (Rép. Populaire de Corée)	KP
Algérie	DZ	Costa Rica	CR
Allemagne	DE	Côte d'Ivoire*	CI
Andorre	AD	Croatie	HR
Angola	AO	Cuba	CU
Anguilla	AI	Danemark	DK
Antigua-et-Barbuda	AG	Djibouti	DJ
Antilles Néerlandaises	AN	Dominicaine, République	DO
Arabie Saoudite	SA	Dominique	DM
Argentine	AR	Egypte	EG
Arménie	AM	El Salvador	SV
Aruba	AW	Emirats Arabes Unis	AE
Australie	AU	Equateur	EC
Autriche	AT	Erythrée	ER
Azerbaïdjan	AZ	Espagne	ES
Bahamas	BS	Estonie	EE
Bahreïn	BH	Etats-Unis d'Amérique	US
Bangladesh	BD	Ethiopie	ET
Barbade	BB	Ex Rep. Yougoslavie de Macedoine	MK
Bélarus	BY	Falkland, Îles (Malvinas)	FK
Belgique	BE	Fédération de Russie	RU
Belize	BZ	Fidji	FJ
Bénin*	BJ	Féroé, Îles	FO
Bermudes	BM	Finlande	FI
Bhoutan	BT	France	FR
Bolivie	BO	Gabon*	GA
Bonaire, Saint-Eustache et Saba	BQ	Gambie	GM
Bosnie-Herzégovine	BA	Géorgie	GE
Botswana	BW	Géorgie du Sud et les Îles Sandwich du Sud	GS
Bouvet, Île	BV	Ghana	GH
Brésil	BR	Gibraltar	GI
Brunéi Darussalam	BN	Grèce	GR
Bulgarie	BG	Grenade	GD
Burkina Faso*	BF	Groenland	GL
Burundi	BI	Guatemala	GT
Caïmanes, Îles	KY	Guernesey	GG
Cambodge	KH	Guinée*	GN
Cameroun*	CM	Guinée-Bissau*	GW
Canada	CA	Guinée Equatoriale*	GQ
Cap-Vert	CV	Guyana	GY
Centrafricaine, République*	CF	Haïti	HT

Chili	CL	Honduras	HN
Chine	CN	Hong Kong	HK
Chypre	CY	Hongrie	HU
Colombie	CO	Île de Man	IM
Comores*	KM	Îles Vierges (Britanniques)	VG
Congo*	CG	Inde	IN
Congo(Rép.Démocratique)	CD	Indonésie	ID
Iran(République Islamique d')	IR	Norvège	NO
Iraq	IQ	Nouvelle-Zélande	NZ
Irlande	IE	Oman	OM
Islande	IS	Ouganda	UG
Israël	IL	Ouzbékistan	UZ
Italie	IT	Pakistan	PK
Jamaïque	JM	Palaos	PW
Japon	JP	Panama	PA
Jersey	JE	Papouasie-Nouvelle-Guinée	PG
Jordanie	JO	Paraguay	PY
Kazakhstan	KZ	Pays-Bas	NL
Kenya	KE	Pérou	PE
Kirghizistan	KG	Philippines	PH
Kiribati	KI	Pologne	PL
Koweït	KW	Portugal	PT
Laos	LA	Qatar	QA
Lesotho	LS	Région admin. Spéciale de Hong Kong (Rep. Populaire de Chine)	HK
Lettonie	LV	Roumanie	RO
Liban	LB	Royaume Uni (Grande Bretagne)	GB
Libéria	LR	Rwanda	RW
Libye	LY	Sahara Occidental	EH
Liechtenstein	LI	Sainte-Hélène	SH
Lituanie	LT	Saint-Kitts-et-Nevis	KN
Luxembourg	LU	Sainte-Lucie	LC
Macao	MO	Saint-Marin	SM
Macédoine	MK	Saint-Marin (Partie Néerlandaise)	SX
Madagascar	MG	Saint-Siège(Vatican)	VA
Malaisie	MY	Saint-Vincent-et-les Grenadines(a,b)	VC
Malawi	MW	Salomon, Îles	SB
Maldives	MV	Samoa	WS
Mali*	ML	SaoTomé-et-Principe	ST
Malte	MT	Sénégal*	SN
Mariannes du Nord, Îles	MP	Serbie	RS
Maroc	MA	Seychelles	SC
Maurice	MU	Sierra Leone	SL
Mauritanie*	MR	Singapour	SG
Mexique	MX	Slovaquie	SK
Moldova	MD	Slovénie	SI
Monaco	MC	Somalie	SO

Mongolie	MN	Soudan	SD
Monténégro	ME	SriLanka	LK
Montserrat	MS	Suède	SE
Mozambique	MZ	Suisse	CH
Myanmar(Birmanie)	MM	Suriname	SR
Namibie	NA	Swaziland	SZ
Nauru	NR	Syrie	SY
Népal	NP	Tadjikistan	TJ
Nicaragua	NI	Taiwan,Province de Chine	TW
Niger*	NE	Tanzanie (Rép.-Unie)	TZ
Nigéria	NG	Tchad*	TD
Thaïlande	TH	Tchèque,République	CZ
Timor Oriental	TP	Ukraine	UA
Togo*	TG	Uruguay	UY
Tonga	TO	Vanuata	VU
Trinité-et-Tobago	TT	Venezuela	VE
Tunisie	TN	VietNam	VN
Turkménistan	TM	Yémen	YE
Turks et Caïques,Îles	TC	Yougoslavie	YU
Turquie	TR	Zambie	ZM
Tuvalu	TV	Zimbabwe	ZW

ORGANISATIONS INTERNATIONALES DELIVRANT OU ENREGISTRANT DES TITRES DE PROPRIETE INDUSTRIELLE

Bureau Benelux des marques et des dessins et modèles industriels	BX
Office Communautaire des variétés végétales (Communauté Européenne (OCVV))	QZ
Office de l'harmonisation dans le marché intérieur (Marque, dessins et modèles)	EM
Office des Brevets du conseil de Coopération des Etats du Golf (CCG)	GC
Office Européen des Brevets (OEB)	EP
Organisation Mondiale de la Propriété Intellectuelle (OMPI)	WO
Bureau International de l'OMPI	IB
Organisation Africaine de la Propriété Intellectuelle (OAPI)	OA
Organisation Eurasienne des Brevets (OEAB)	EA
Organisation Régionale Africaine de la Propriété Industrielle (ARIPO)	AP

*Etats membres de l'OAPI

**CODES UTILISES EN MATIERE DE DOCUMENTATION DES
BREVETS D'INVENTION ET DES MODELES D'UTILITE**

- (11) Numéro de publication.
- (12) Désignation du type de document.
- (19) Identification de l'office qui publie le document.
- (21) Numéro d'enregistrement ou de dépôt.
- (22) Date de dépôt.
- (24) Date de délivrance.
- (30) Pays dans lequel (lesquels) la(les) demande(s) de priorité a (ont) été déposée(s).
Date(s) de dépôt de la (des) demande(s) de priorité.

(le cas échéant)

Numéro(s) attribué(s) à la (aux) demande(s) de priorité.

- (51) Classification internationale des brevets(CIB).
- (54) Titre de l'invention.
- (57) Abrégé.
- (60) Références à d'autres documents apparentés (le cas échéant).
- (71) Nom(s) du ou des demandeur(s).
- (72) Nom de l'inventeur (le cas échéant) suivi éventuellement du nom de la société d'appartenance.
- (73) Nom(s) du ou des titulaire(s) le cas échéant.
(Ce code n'apparaît que sur la première page du brevet délivré)
- (74) Nom du mandataire en territoire OAPI (le cas échéant).

**CODES UTILISES EN MATIERE D'INSCRIPTIONS
DANS LE REGISTRE SPECIAL DES BREVETS D'INVENTION ET DES
MODELES D'UTILITE**

- (1) Numéro de délivrance
- (2) Numéro de dépôt
- (3) Numéro et date de la demande d'inscription
- (4) Nature de l'inscription
- (5) Numéro et date de l'inscription
- (10) Cédant
- (11) Cessionnaire
- (12) Apporteur
- (13) Bénéficiaire
- (14) Dénomination avant
- (15) Dénomination après
- (16) Concédant
- (17) Titulaire
- (18) Ancienne adresse
- (19) Nouvelle adresse
- (20) Constituant du nantissement
- (21) Créancier nanti

CLARIFICATION DU REGLEMENT RELATIF A L'EXTENSION DES DROITS SUITE A UNE NOUVELLE ADHESION A L'ACCORD DE BANGUI

RESOLUTION N°47/32

LE CONSEIL D'ADMINISTRATION DE L'ORGANISATION AFRICAINE DE LAPROPRIETE INTELLECTUELLE

- Vu L'accord portant révision de l'accord de Bangui du 02 Mars 1977 instituant une Organisation Africaine de la Propriété Intellectuelle et ses annexes ;
- Vu Les dispositions des articles 18 et 19 dudit Accord relatives Aux attributions et pouvoirs du Conseil d'Administration ;

ADOPTE la clarification du règlement du 04 décembre 1988 relatif à l'extension des droits suite à une nouvelle adhésion à l'Accord de Bangui ci-après :

Article 1er :

Le Règlement du 04 décembre 1988 relatif à l'extension des droits suite à une nouvelle adhésion à l'Accord de Bangui est réaménagé ainsi qu'il suit :

« Article 5 (nouveau) » :

Les titulaires des titres en vigueur à l'Organisation avant la production des effets de l'adhésion d'un Etat à l'accord de Bangui ou ceux dont la demande a été déposée avant cette date et qui

voudront étendre la protection dans ces Etats doivent formuler une demande d'extension à cet effet auprès de l'Organisation suivant les modalités fixées aux articles 6 à 18 ci-dessous.

Le renouvellement de la protection des titres qui n'ont pas fait l'objet d'extension avant l'échéance dudit renouvellement entraîne une extension automatique des effets de la protection à l'ensemble du territoire OAPI».

Le reste sans changement.

Article 2 :

La présente clarification, qui entre en vigueur à compter du 1^{er} janvier 2008, s'applique aussi aux demandes d'extension en instance et sera publiée au Bulletin Officiel de l'Organisation.

Fait à Bangui le 17 décembre 2007

STRUCTURES NATIONALES DE LIAISON (SNL)

BENIN-Cotonou

Agence Nationale de la Propriété Industrielle (ANAPI)

Tel.: (229) 21 31 02 40
Fax.: (229) 21 30 30 24
01 B.P. 363 Cotonou 01

BURKINA FASO-Ouagadougou

Direction Nationale de la Propriété Industrielle (DNPI)

(Ministère de l'Industrie, du Commerce et de l'Artisanat)
Tél. : (226) 50 30 09 41
Fax : (226) 50 33 05 63
01 B.P. 258 Ouagadougou

CAMEROUN-Yaoundé

Direction du Développement Technologique et de la Propriété Industrielle

(Ministère des Mines, de l'Industrie et du Développement Technologique)
Tel. : (237) 22 20 37 78
Fax: (237) 22 20 37 38
B.P. 1652 Yaoundé

CENTRAFRIQUE-Bangui

Direction de la Propriété Industrielle (Ministère du Commerce et de l'Industrie)

Tél. : (236) 21 61 17 44
Fax : (236) 21 61 76 53
Avenue B. BOGANDA
B.P. 1988 Bangui

COMORES-Moroni

Office comorien de la propriété intellectuelle

Tél. : 269 333 53 60
Fax : 269 775 00 03
B.P. 41 Moroni

CONGO-Brazzaville

Antenne Nationale de la Propriété Industrielle (ANPI)

(Ministère du Développement Industriel et de la Promotion du Secteur Privé)
Tél. : (242) 581 56 57
Fax : (242) 581 54 80
B.P. : 72 Brazzaville

COTE D'IVOIRE-Abidjan

Office Ivoirien de la Propriété Industrielle (OIPD)

Tel. : (225) 20 33 53 43/44
Fax: (225) 20 33 53 45
01 B.P. 2337 Abidjan

GABON-Libreville

Centre de la Propriété Industrielle du Gabon (CEPIG)

(Ministère du Commerce et du Développement Industriel, Chargé du NEPAD)
Tel. : (241) 01 74 59 24
Fax : (241) 01 76 30 55
B.P. : 1025 Libreville

GUINEE-Conakry

Service National de la Propriété Industrielle

(Ministère de l'Industrie, des Petites et Moyennes Entreprises)
Tel. : (224) 30 41 17 20/60 58 53 61
Fax: (224) 41 25 42/41 39 90
B.P. 468 Conakry

GUINEE BISSAU-Bissau

Direction Générale de la Propriété Industrielle

(Ministère du Commerce, de l'Industrie et de la Promotion des Produits locaux)
Tél : (245) 322 22 75
Fax : (245) 322 37 65
B.P. : 269 Bissau

GUINEE EQUATORIALE-Malabo

Direction de la Propriété Intellectuelle

(Conseil de la Recherche Scientifique et Technique - CICTE)
Tel. : (240) 222 09 24 84
Fax : (240) 333 09 33 13
B.P. : 528 Malabo

MALI-Bamako

Centre Malien de la Propriété Industrielle (CEMAPI)

Tel. : (223) 20 29 90 90
Fax: (223) 20 29 90 91
B.P. : 278 Bamako

MAURITANIE-Nouakchott

Service de la Technologie et de la Propriété Industrielle

(Ministère du Commerce, de l'Industrie, de l'Artisanat et du Tourisme)
Tel. : (222) 525 72 66
Fax: (222) 525 69 37
B.P. : 387 Nouakchott

NIGER-Niamey

Direction de l'Innovation et de la Propriété Intellectuelle

(Ministère des Mines et du Développement Industriel)
Tél. : (227) 20 73 58 25
Fax : (227) 20 73 21 50
B.P. : 480 Niamey

SENEGAL-Dakar

Agence Sénégalaise pour la Propriété Industrielle et l'Innovation Technologique (ASPIT)

Tel. : (221) 33 869 47 70
Fax: (221) 33 827 30 14
B.P. : 4037 Dakar

TCHAD-N'djamena

Division de la Propriété Industrielle et de la Technologie

(Ministère du Commerce et de l'Industrie)

Tel. : (235) 22 52 08 67
Fax: (235) 22 52 21 79
B.P. : 424 N'Djamena

TOGO-Lomé

Institut National de la Propriété Industrielle et de la Technologie (INPIT)

Tel. : (228) 222 10 08
Fax : (228) 222 44 70
B.P. : 2339 Lomé



OAPI

B.P. 887 Yaoundé-Cameroun Tél : (237) 22 20 57 00

E-mail : oapi@oapi.int

Fax : (237) 22 20 57 27

www.oapi.int

DEUXIEME PARTIE
BREVETS D'INVENTION

A

REPertoire NUMERIQUE

(11) **17116**(51) A61K 31/407; A61P 29/02; A61P 35/00
C07D 487/08

(21) 1201100171 - PCT/IB09/055232

(22) 20.11.2009

(30) US n° 61/118,053 du 26/11/2008

(54) Aminocyclopentanecarboxamides as
chemokine receptor modulators.(72) DEVRAJ, Rajesh Venkateswaran;
HUANG, Wei;
HUGHES, Robert Owen;
ROGIER JR., Donald Joseph;
TRUJILLO, John Isidro;
TURNER, Steve Ronald.

(73) PFIZER INC. (US)

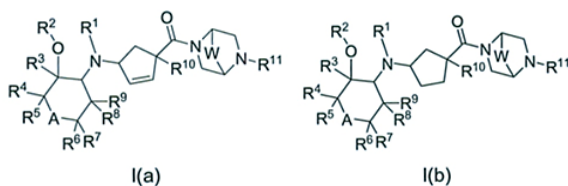
(74) SCP AKKUM, AKKUM & Associates,
Quartier Mballa II, Dragages, B.P. 4966,
YAOUNDE (CM).(57) There is provided a compound of formula
I(a) or I(b)

or a pharmaceutically acceptable salt thereof,
wherein the various substituents are defined
herein.

[Consulter le mémoire](#)

(11) **17117**(51) A61K 39/395; A61K 38/16; A61K 38/17
A61P 5/00

(21) 1201400387 - PCT/US13/028456

(22) 28.02.2013

(30) US n° 61/605181 du 29/02/2012

US n° PCT/US2012/027160 du 29/02/2012

US n° 61/755444 du 22/01/2013

(54) Antibodies to matrix metalloproteinase 9.

(72) ADAMKEWICZ Joanne I.;
SMITH Victoria;

THAI Zung;

HAWKINS Michael J.

(73) Gilead Biologics, Inc. (US)

(74) Cabinet ÉKÉMÉ LYSAGHT SARL,
B.P. 6370, YAOUNDE (CM).

(57) The present disclosure provides
compositions and methods of use involving
binding proteins, e.g., antibodies and antigen-
binding fragments thereof, that bind to the matrix
metalloproteinase-9 (MMP9) protein (MMP9 is
also known as gelatinase-B), such as where the
binding proteins comprise an immunoglobulin (Ig)
heavy chain (or functional fragment thereof) and
an Ig light chain (or functional fragment thereof).

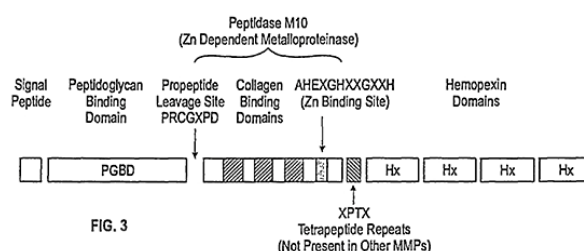

Fig. 3

[Consulter le mémoire](#)

(11) **17118**(51) A01N 43/40; A01N 37/50; A01P 7/00
A01N 47/02; A01N 51/00

(21) 1201400392 - PCT/JP13/056051

(22) 27.02.2013

(30) JP n° 2012-044514 du 19/02/2012

(54) Pest control composition including novel
iminopyridine derivative.(72) HORIKOSHI, Ryo
ONOZAKI, Yasumichi
NAKAMURA, Satoshi
NOMURA, Masahiro
MATSUMURA, Makoto
MITOMI, Masaaki.

(73) Meiji Seika Pharma Co., Ltd. (JP)

(74) Cabinet Spoor & Fisher Inc. Ngwafor &
Partners, Blvd. du 20 Mai, Immeuble Centre
Commercial de l'Hôtel Hilton, 2è Etage, Porte
208A, B.P. 8211, YAOUNDE (CM).

(57) Provided is a pest control composition containing a novel iminopyridine derivative and other pest control agents. Provided is a pest control composition containing an iminopyridine derivative represented by the following formula (I)

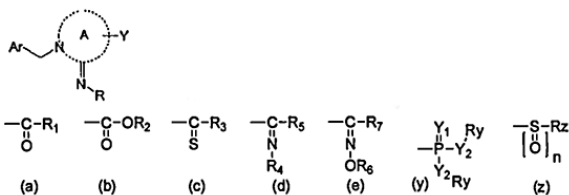

and at least one of other pest control agents : [chemical formula 1] [in the formula, Ar represents a 5- to 6-membered heterocycle which may be substituted, A represents a heterocycle having a 5- to 10-membered unsaturated bond including one or more nitrogen atoms, and has an imino group substituted with an R group at a position adjacent to the nitrogen atom present on the cycle, Y represents hydrogen, halogen and the like, and R represents any one of groups represented by the following formulae (a) to (e), (y) or (z)]. [Chemical formula 2].

[Consulter le mémoire](#)

(11) **17119**

(51) A61F 2/04; A61L 27/18; A61L 27/58

(21) 1201400394 - PCT/EP13/054538

(22) 06.03.2013

(30) IT n° MI2012A 000380 du 12/03/2012

(54) Improved absorbable cap for bladder enlargement in patients with low compliance or for the replacement of a vast portion of bladder following bilharzia.

(72) Sambusseti, Antonio.

(73) Sambusseti, Antonio (IT)

(74) Cabinet Spoor & Fisher Inc. Ngwafor & Partners, Blvd. du 20 Mai, Immeuble Centre Commercial de l'Hôtel Hilton, 2è Etage, Porte 208A, B.P. 8211, YAOUNDE (CM).

(57) A description is given of a domed cap (100) for the enlargement of an atrophied bladder (200), in biocompatible and absorbable material comprising a textile (1) made with yarns or with monofilaments deriving from PGA fibres, characterised in that said textile (1) is supported

by a star-shaped frame with domed profile, formed by a plurality of radial strips (3) manufactured by injection of a PGA/PLA copolymer, said cap (100) being suitable for growing thereon autologous fibrous capsule cells, generated by the process of tissue reconstruction, after its insertion inside the patient.

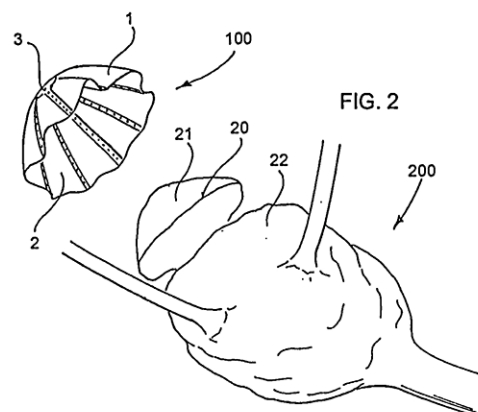

[Consulter le mémoire](#)

(11) **17120**

(51) A61F 2/04; A61L 27/18; A61L 27/58

(21) 1201400397 - PCT/EP13/054540

(22) 06.03.2013

(30) IT n° MI2012A 000381 du 12/03/2012

(54) Improved absorbable patch, in reinforced PGA, for the replacement of a portion of bladder wall following partial cystectomy.

(72) Sambusseti, Antonio.

(73) Sambusseti, Antonio (IT)

(74) Cabinet Spoor & Fisher Inc. Ngwafor & Partners, Blvd. du 20 Mai, Immeuble Centre Commercial de l'Hôtel Hilton, 2è Etage, Porte 208A, B.P. 8211, YAOUNDE (CM).

(57) A description is given of a patch (1) for the replacement of a portion of bladder wall, following partial cystectomy, comprising a textile (2) deriving from a PGA yarn and provided with a star-shaped support frame, flexible and harmonic, formed by a plurality of radial strips (3) manufactured by injection of a PGA/PLA copolymer, said patch (1) being suitable for making autologous fibrous capsule cells, generated by the process of tissue reconstruction, grow thereon after its insertion inside the patient.

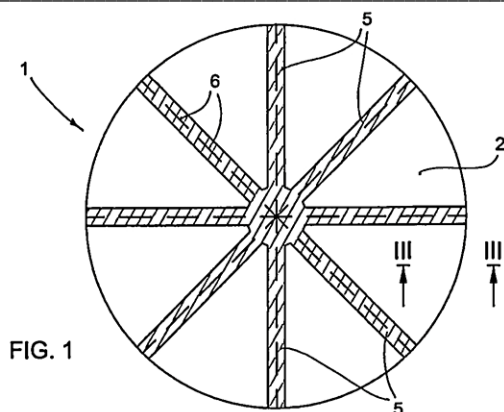

FIG. 1

[Consulter le mémoire](#)

(11) **17121**

(51) C07D 491/08; C07D 498/18; C07D 513/18
A61P 35/00; A61K 31/4353

(21) 1201400399 - PCT/IB13/051391

(22) 20.02.2013

(30) US n° 61/607,485 du 06/03/2012
US n° 61/759,307 du 31/01/2013

(54) Macrocyclic derivatives for the treatment of proliferative diseases.

(72) BAILEY, Simon

BURKE, Benjamin, Joseph

COLLINS, Michael, Raymond

CUI, Jingrong, Jean

DEAL, Judith, Gail

HOFFMAN, Robert, Louis

HUANG, Qinhu

JOHNSON, Ted, William

KANIA, Robert, Steven

KATH, John, Charles

LE, Phuong, Thi, Quy

MCTIGUE, Michele, Ann

PALMER, Cynthia, Louise

RICHARDSON, Paul, Francis

SACH, Neal, William.

(73) PFIZER INC. (US)

(74) SCP AKKUM, AKKUM & Associates,
Quartier Mballa II, Dragages, B.P. 4966,
YAOUNDE (CM).

(57) The invention relates to compounds of formula (F) as further defined herein and to the pharmaceutically acceptable salts thereof, to

pharmaceutical compositions comprising such compounds and salts, and to the uses thereof. The compounds and salts of the present invention inhibit anaplastic lymphoma kinase (ALK) and/or EML4-ALK and are useful for treating or ameliorating abnormal cell proliferative disorders, such as cancer.

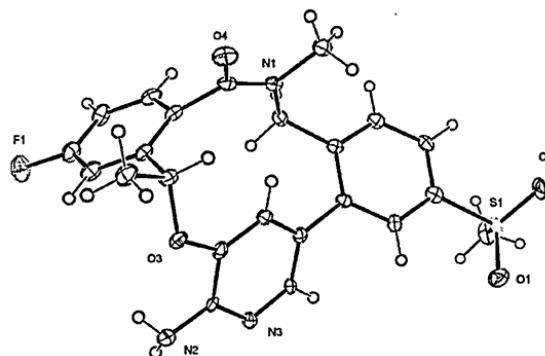

Figure 1

[Consulter le mémoire](#)

(11) **17122**

(51) A01N 65/00

(21) 1201400401

(22) 02.09.2014

(54) Thé de feuilles de cacao.

(72) AYISSI Charles.

(73) AYISSI Charles, Gie Sun Sud Cameroun,
B.P. 99, NTUI (CM).

(57) La présente invention porte sur un thé fabriqué à base de feuilles de cacao. Ce produit obtenu suivant un nombre d'étapes particulières, est tout comme les autres produits dérivés du cacao, plein de valeurs nutritives et thérapeutiques fournies par les flavonoïdes dont ils sont riches; au-delà de l'aspect cardiovasculaire, le thé de feuilles de cacao peut être actif dans la lutte contre des cancers, maladies inflammatoires et troubles de la fonction immunitaire. De conservation facile et non polluant, ce thé a l'avantage d'avoir un effet un peu plus durable que les thés classiques.

[Consulter le mémoire](#)

(11) **17123**

(51) C07D 473/34; A61K 31/52; A61P 35/02

(21) 1201400405 - PCT/US13/029157

(22) 05.03.2013

(30) US n° 61/606870 du 05/03/2012

(54) Polymorphic forms of (S)-2-(1-(9H-purin-6-ylamino)propyl)-5-fluoro-3-phenylquinazolin-4(3H)-one.

(72) CARRA Ernest
GERBER Michael
SHI Bing
TRAN Duong
SUJINO Keiko
WANG Fang
EVARTS Jerry B.

(73) Gilead Calistoga LLC (US)

(74) Cabinet ÉKÉMÉ LYSAGHT SARL,
B.P. 6370, YAOUNDE (CM).

(57) Polymorphs of (S)-2-(1-(9H-purin-6-ylamino)propyl)-5-fluoro-3-phenylquinazolin-4(3H)-one, compositions thereof, methods for their preparation, and methods for their use are disclosed.

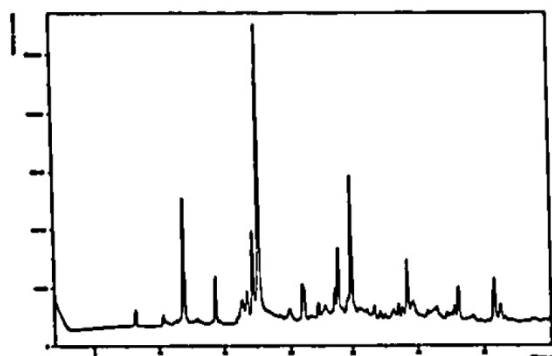

FIG. 1A

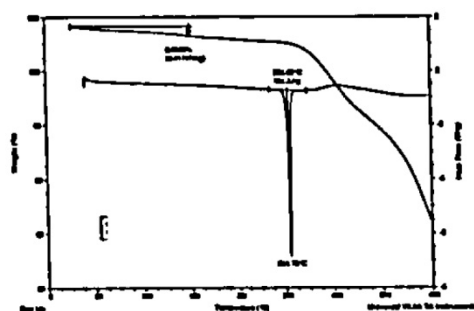

FIG. 1B

Fig. (1a et 1b)

[Consulter le mémoire](#)

(11) **17124**

(51) C07D 311/36; C07D 405/06

(21) 1201400408 - PCT/IB13/053544

(22) 03.05.2013

(30) IN n° 1737/CHE/2012 du 04/05/2012

US n° 61/671,956 du 16/07/2012

(54) Process for preparation of optically pure and optionally substituted 2-(1-Hydroxy-Alkyl) - Chromen - 4 - one derivatives and their use in preparing pharmaceuticals.

(72) RAMAN, Jayaraman Venkat;

VAKKALANKA, Swaroop Ku-mar Venkata Satya.

(73) Rhizen Pharmaceuticals SA, Fritz Courvoisier 40, CH-2300 LA CHAUX-DE-FONDS (CH)

(74) Cabinet Spoor & Fisher Inc. Ngwafor & Partners, Blvd. du 20 Mai, Immeuble Centre Commercial de l'Hôtel Hilton, 2è Etage, Porte 208A, B.P. 8211, YAOUNDE (CM).

(57) The present invention relates to compounds useful as pharmaceutical intermediates, to processes for preparing the intermediates, to intermediates used in the processes, and to the use of the intermediates in the preparation of pharmaceuticals. In particular, the present invention concerns enantiomerically pure optionally substituted 2-(1-hydroxy-alkyl)-chromen-4-one derivatives represented by formula (IA) and (IB), processes for preparing the alcohol derivatives and their use in preparing pharmaceuticals.

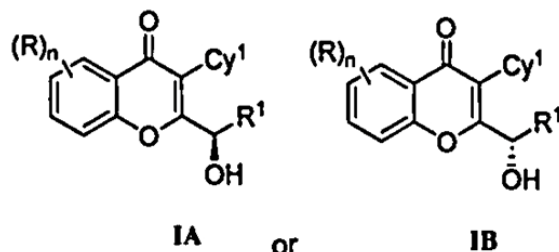

Fig. (1a et 1b)

[Consulter le mémoire](#)

(11) **17125**

(51) A61K 33/00; A61K 35/14; A61P 29/00
A61K 38/18

(21) 1201400409 - PCT/IB13/051739

(22) 05.03.2013

(30) IT n° MI2012A000338 du 06/03/2012

(54) Theurapeutic preparation and process for preparing said theurapeutic preparation.

(72) BIGNOTTI, Andrea

TURELLI, Chiara.

(73) BIGNOTTI, Andrea (IT)

TURELLI, Chiara (IT).

(74) SCP GLOBAL AFRICA IP, Base Buns, Mvog Betsi, (Sise Nouveau Marché), B.P. 3694, YAOUNDE (CM).

(57) A therapeutic preparation (1) comprising ozonised oil and a platelet concentrate (2), mixed according to a mixing ratio between the volumes of the platelet concentrate (2) and of the ozonised oil (3) substantially in the range between 2 and 4.

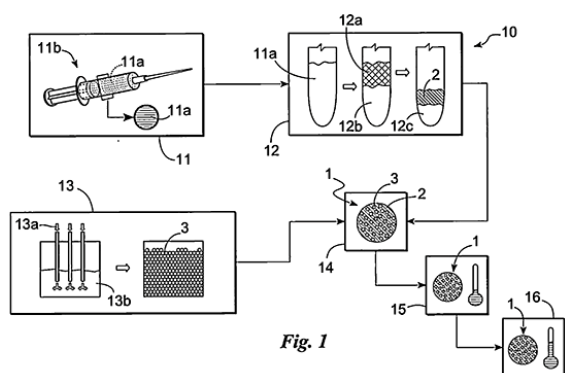

Fig. 1

[Consulter le mémoire](#)

(11) **17126**

(51) A61K 39/395; C07K 16/24; A61K 9/19

(21) 1201400412 - PCT/IN13/000129

(22) 05.03.2013

(30) IN n° 610/MUM/2012 du 07/03/2012

IN n° 1606/MUM/2012 du 30/05/2012

IN n° 3031/MUM/2012 du 17/10/2012

(54) Pharmaceutical formulations of TNF-alpha antibodies.

(72) MENDIRATTA Sanjeev Kumar

BANDYOPADHYAY Sanjay

PATEL Chintan G.

(73) Cadila Healthcare Limited (IN)

(74) Cabinet ÉKÉMÉ LYSAGHT SARL, B.P. 6370, YAOUNDE (CM).

(57) The present invention provides certain improved formulations of proteins. Specifically, the present invention provides use of certain excipients that are useful for stabilization of antibody preparations. Additionally, the novel formulation of the present invention prevents the

formation of aggregates or fragments or modification of protein in solution.

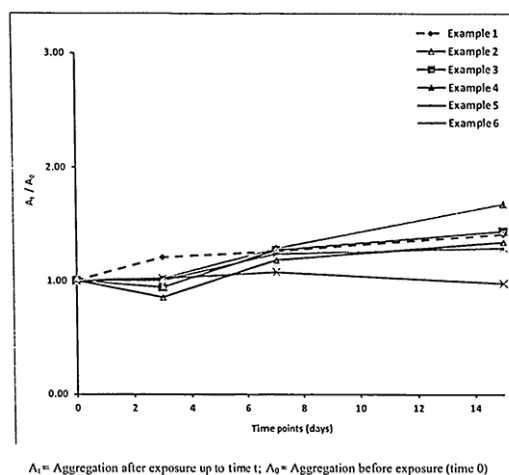

Fig. 1

[Consulter le mémoire](#)

(11) **17127**

(51) C02F 1/42

(21) 1201400415

(22) 01.09.2014

(54) Procédé de potabilisation des eaux brutes de surface pour la consommation.

(72) M. NAOUNOU Tapé Luc.

(73) M. NAOUNOU Tapé Luc, 23 B.P. 965, ABIDJAN 23 (CI).

(57) L'invention est un procédé de potabilisation qui est décrit comme suit : pompage des eaux brutes de surface, dans les bassins de lagunage à ciel ouvert; traitement physico-chimique naturel par biodégradabilité; traitement physique par absorption sur filtre à charbon bio actifNT en grains; traitement physico-chimique (neutralisation des colloïdes, diminution du PH (sulfate d'aluminium en solution) de floculation, oxydation en milieu acide, coagulation au PH de floculation suivi de la floculation; traitement physique (décantation à flux horizontal) ; filtration sur sable activéNT et percolation à la neutralite, pour une minéralisation et une neutralisation de l'acide carbonique ; traitement par absorption sur filtre à charbon bio actifNT en grains, traitement chimique (désinfection et stérilisation en milieu acide; traitement par stockage de l'eau traitée (bâche) et distribution gravitaire à partir des châteaux d'eau.

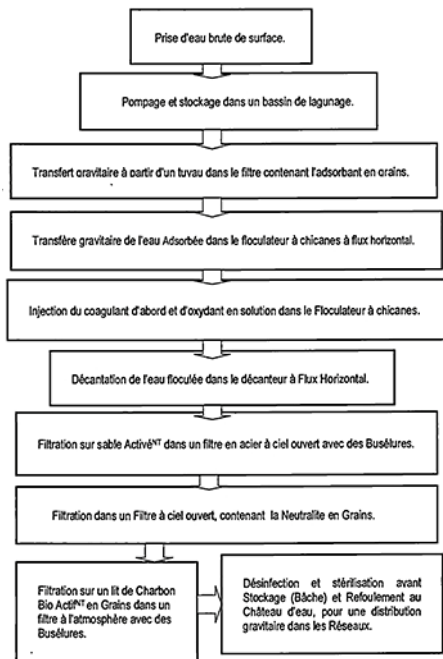

[Consulter le mémoire](#)

(11) **17128**

(51) F16L 15/04 (06.01)

(21) 1201400521 - PCT/JP13/064558

(22) 21.05.2013

(30) JP n° 2012-117550 du 23/05/2012

(54) Tubular threaded joint having improved high-torque makeup properties.

(72) GOTO, Kunio.

(73) Nippon Steel & Sumitomo Metal Corporation (JP)

&

Vallourec Oil and Gas France (FR).

(74) Cabinet Spoor & Fisher Inc. Ngwafor & Partners, Blvd. du 20 Mai, Immeuble Centre Commercial de l'Hôtel Hilton, 2è Etage, Porte 208A, B.P. 8211, YAOUNDE (CM).

(57) In a tubular threaded joint composed of a pin 1 and a box 2 each having a contact surface comprising a threaded portion and an unthreaded metal contact portion including a seal portion and a shoulder portion, a solid lubricating coating 10 having a relatively high Knoop hardness is formed on a portion including the shoulder portion of the contact surface (such as the unthreaded metal contact portion including the shoulder portion and the seal portion) of at least one of the pin and the box, and a solid lubricating coating 11 having a relatively low Knoop hardness is formed at least

on the remaining portion of the contact surface (such as the threaded portion). The tubular threaded joint has excellent galling resistance, gas tightness, and rust preventing properties, and since it has a large ΔT , it does not readily undergo yielding of shoulder portions even when it is made up with a high torque, thereby making it possible to perform makeup in a stable manner.

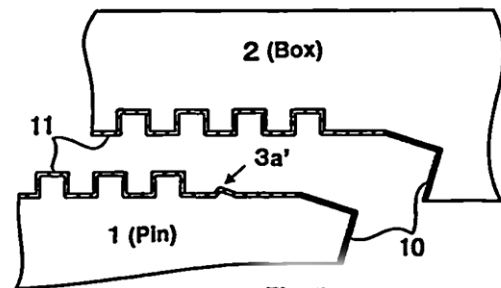

[Consulter le mémoire](#)

(11) **17129**

(51) E01B 9/30 (06.01)

(21) 1201400524 - PCT/EP13/061460

(22) 04.06.2013

(30) EP n° 12170731.9 du 04/06/2012

(54) Guide plate for fastening rails for rail vehicles.

(72) KRIEG, Nikolaj

GNACZYNSKI, Martin.

(73) VOSSLOH-WERKE GMBH (DE)

(74) SCP AKKUM, AKKUM & Associates, Quartier Mballa II, Dragages, B.P. 4966, YAOUNDE (CM).

(57) The invention provides a guide plate for the attachment of rails (S) for rail vehicles with further reduced weight and optimised performance characteristics. To this end, the guide plate has at least one recess (30-34) moulded into the guide plate from the underside (11) on which the guide plate (3) stands in the assembly position, a support surface (13) formed on the upper side (10) of the guide plate (3) for a spring element (1,2) envisaged for holding down the rail (S) to be attached and a contact surface (9) provided on one face of the guide plate (3) which extends in the longitudinal direction of the guide plate (3) and at the side of which, in the assembly position, the rail (S) to be attached is guided. According to the invention, at least one reinforcing rib (21) is provided on the upper side (10) of the guide plate

(3) which rises above the support surface (13) and extends crosswise to the contact surface (9). At the same time, according to the invention, the recess moulded into the guide plate (3) from the underside (11) reaches into the area of the guide plate (3) in which the reinforcing rib (21) is provided.

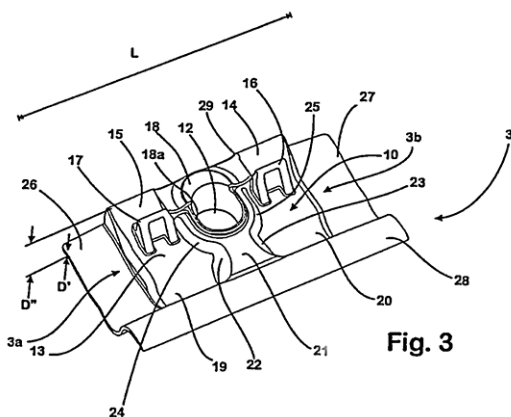

[Consulter le mémoire](#)

(11) **17130**

(51) C04B 7/13; C04B 28/04; C04B 20/02

(21) 1201400424 - PCT/EP13/054907

(22) 11.03.2013

(30) SE n° 1250225-8 du 12/03/2012

(54) Method for manufacturing of supplementary cementitious materials (SCMS).

(72) RONIN, Vladimir.

(73) Procedo Enterprises Etablissement (LI)

(74) Cabinet Spoor & Fisher Inc. Ngwafor & Partners, Blvd. du 20 Mai, Immeuble Centre Commercial de l'Hôtel Hilton, 2è Etage, Porte 208A, B.P. 8211, YAOUNDE (CM).

(57) Method for manufacturing of supplementary cementitious materials for replacement of Portland cement in production of mortars and concretes, where the cementitious materials comprises natural pozzolans in the form of rocks and ashes. The invention is characterized in, that the said pozzolans in crushed state are subjected to a high energetic mechanical processing by means of grinding in a grinding equipment, whereby the pozzolan particles receive mechanical impulses, and in that the grinding is carried out for a predetermined time resulting in a compressive strength of a 2 inch side cube of mortar comprising 80 % Portland cement and 20 % natural pozzolan in a ratio of 1:2.75 to standard

sand and in addition water required to obtain a flow of the mortar according to American standard ASTM C 109, which has been properly compacted under vibration and hardened at + 20 °C in sealed condition, which after 28 days is = 75 % of the compressive strength of a 2 inch side cube, treated as said cube, of a mortar comprising a ratio of Portland cement: sand of 1:2.75 and in addition water corresponding to 48.5 % of the weight of Portland cement.

[Consulter le mémoire](#)

(11) **17131**

(51) A61K 31/704; A61K 31/7068

(21) 1201400427 - PCT/EP13/055137

(22) 13.03.2013

(30) EP n° 12305295.3 du 14/03/2012

(54) Novel combinations for treating acute myeloid leukaemia or chronic myeloid leukaemia.

(72) BOURRIE Bernard

CASELLAS Pierre

COSNIER-PUCHEU Sylvie

JEGHAM Samir

PERREAUT Pierre.

(73) SANOFI (FR)

(74) Cabinet CAZENAVE SARL, B.P. 500, YAOUNDE (CM).

(57) The present invention relates to combinations of N-[2-(2,1,3-benzothiazol-5-ylamino)-6-(2,6-dichlorophenyl) pyrido[2,3-d]pyrimidin-7-yl]-N'-(1,1-dimethylethyl)-urea and cytarabine and their use for treating AML or CML.

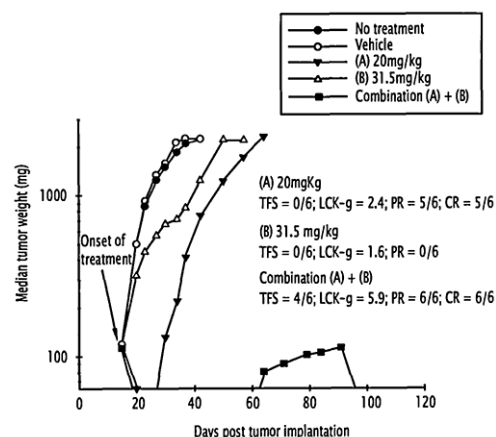

Fig. 1

[Consulter le mémoire](#)

(11) **17132**

(51) A61B 10/00; C12Q 1/66; A61B 17/32

(21) 1201400428

(22) 12.09.2014

(54) Procédé de calcul du cycle féminin.

(72) INDJENDJET GONDJOUT Franck Dilard Paul.

(73) INDJENDJET GONDJOUT Franck Dilard Paul (GA)

(74) Cabinet CAZENAVE SARL, B.P. 500, YAOUNDE (CM).

(57) L'invention concerne un procédé de calcul et du cycle féminin d'une utilisatrice, comportant les étapes suivantes : - envoi par l'utilisatrice, à l'aide d'un terminal informatique, d'une requête à un dispositif externe, - réception de la requête audit dispositif externe, - reconnaissance de l'utilisatrice par le dispositif externe, - si le dispositif externe reconnaît l'utilisatrice en tant qu'utilisatrice abonnée, alors : * dans le dispositif externe, interprétation de la requête et calcul d'informations concernant le cycle de l'utilisatrice, * envoi audit terminal informatique desdites informations,* réception et affichage desdites informations sur un écran dudit terminal informatique. L'invention concerne également un dispositif pour le calcul et du cycle féminin d'une utilisatrice, comportant : - au moins une languette comportant sur une première face, ou recto, une échelle graduée représentant les jours d'un premier et d'un deuxième mois consécutifs, - un support (200) allongé à l'intérieur duquel une desdites languettes peut coulisser, ledit support comportant sur une face supérieure (220) comportant une première (221) et une deuxième (222) ouvertures, de façon que, lorsqu'une languette se trouve à l'intérieur du support, une graduation correspondant à seul un jour sur la languette est visible dans chaque ouverture, l'écart entre la première et la deuxième ouvertures étant égal à vingt-sept jours de l'échelle de la languette.

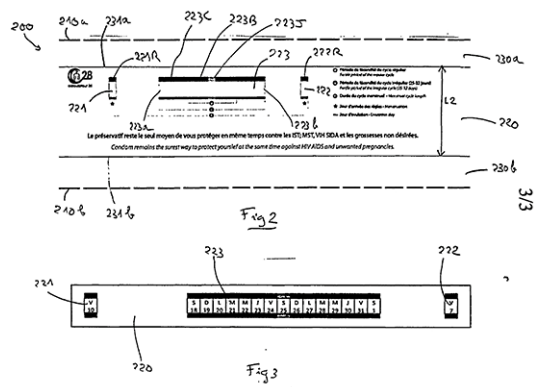
[Consulter le mémoire](#)(11) **17133**

(51) C07D 471/04

(21) 1201400430 - PCT/IB13/051908

(22) 11.03.2013

(30) IN n° 288/KOL/2012 du 14/03/2012

(54) Heterocyclyl compounds as MEK inhibitors.

(72) DAVE, Bhavesh,
BANERJEE, Rakesh, Kumar,
PHUKAN, Samiron,
KHOJE, Abhijit, Datta,
HANGARGE, Rajkumar,
JADHAV, Jitendra, Sambhaji,
PALLE, Venkata, P.,
KAMBOJ, Rajender, Kumar.

(73) Lupin Limited (IN)

(74) Cabinet Spoor & Fisher Inc. Ngwafor & Partners, Blvd. du 20 Mai, Immeuble Centre Commercial de l'Hôtel Hilton, 2è Etage, Porte 208A, B.P. 8211, YAOUNDE (CM).

(57) The present disclosure is related to heteroaryl compounds as MEK inhibitors. These compounds include heteroaryl compounds of formula (I), their pharmaceutically acceptable salts, combinations with suitable medicament and pharmaceutical compositions thereof. The present disclosure also includes processes of preparation of the compounds and their use in methods of treatment. The compounds as disclosed herein are of formula (I) below:

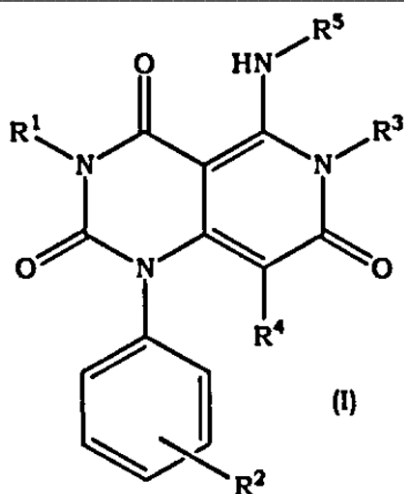

[Consulter le mémoire](#)

(11) **17134**

(51) C02F 1/66; C22B 7/00

(21) 1201400431 - PCT/IB13/051943

(22) 12.03.2013

(30) ZA n° 2012/02073 du 20/03/2012

(54) Treatment of acid mine drainage.

(72) JACOBS, Jan, Hendrik, Phillipus,
FREEMAN, Robert, George.

(73) MINTAILS MINING SA (PTY) LIMITED (ZA)

(74) SCP AKKUM, AKKUM & Associates,
Quartier Mballa II, Dragages, B.P. 4966,
YAOUNDE (CM).

(57) A method for treating acid mine drainage includes mixing acid mine drainage and alkaline tailings from a gold recovery process. The acid mine drainage is thereby neutralized.

Fig. 3

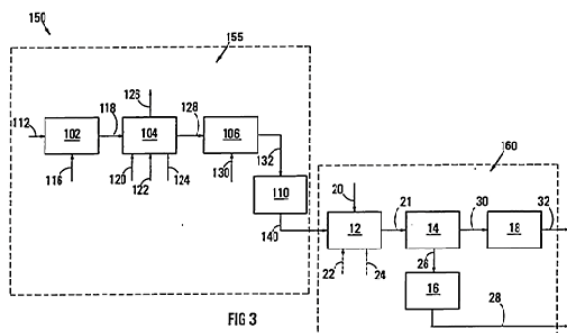

FIG 3

[Consulter le mémoire](#)

(11) **17135**

(51) A61K 31/7068; A61K 31/7076;
A61K 31/7072; A61K 31/708

(21) 1201400433 - PCT/US13/033018

(22) 19.03.2013

(30) US n° 61/613,836 du 21/03/2012

US n° 13/721,988 du 20/12/2012

(54) Substituted nucleosides, nucleotides and analogs thereof.

(72) WANG, Guangyi,
SMITH, David, Bernard,
BEIGELMAN, Leonid,
DEVAL, Jerome,
PRHAVC, Marija.

(73) ALIOS BIOPHARMA, INC. (US)

(74) SCP AKKUM, AKKUM & Associates,
Quartier Mballa II, Dragages, B.P. 4966,
YAOUNDE (CM).

(57) Disclosed herein are nucleosides, nucleotides and analogs thereof, pharmaceutical compositions that include one or more of nucleosides, nucleotides and analogs thereof, and methods of synthesizing the same. Also disclosed herein are methods of ameliorating and/or treating a disease and/or a condition, including an infection from a paramyxovirus and/or an orthomyxovirus, with a nucleoside, a nucleotide and an analog thereof.

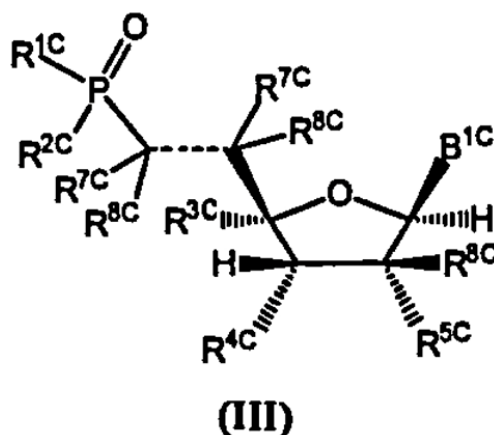

[Consulter le mémoire](#)

(11) **17136**

(51) C07D 405/14; A61K 31/343; A61P 3/10

(21) 1201400436 - PCT/EP13/056312

(22) 25.03.2013

(30) EP n° 12161240.2 du 26/03/2012

(54) New indanyloxydihydrobenzofuranylacetic acid derivatives and their use as GPR40 receptor agonists.

(72) ECKHARDT Matthias,
FRATTINI Sara,
HAMPRECHT Dieter,
HIMMELSBACH Frank,
LANGKOPF Elke,
LINGARD Iain,
PETERS Stefan,
WAGNER Holger.

(73) Boehringer Ingelheim International GmbH (DE)

(74) Cabinet ÉKÉMÉ LYSAGHT SARL, B.P. 6370, YAOUNDE (CM).

(57) The present invention relates to compounds of general formula I

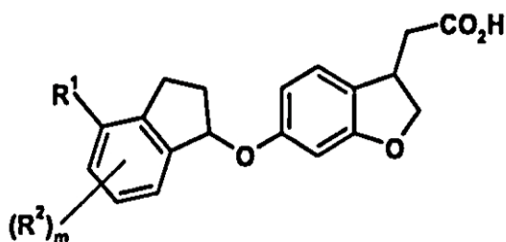

wherein the groups R^1 , R^2 and m are defined as in claim 1, which have valuable pharmacological properties, in particular bind to the GPR40 receptor and modulate its activity. The compounds are suitable for treatment and prevention of diseases which can be influenced by this receptor, such as metabolic diseases, in particular diabetes type 2.

[Consulter le mémoire](#)

(11) **17137**

(51) A61K 39/255; A61P 31/22

(21) 1201400437 - PCT/US13/032539

(22) 15.03.2013

(30) US n° 61/614142 du 22/03/2012

(54) Modified marek's disease virus, and vaccines made therefrom.

(72) PRITCHARD Joyce,
MEBATION Teshome,
BUBLOT Michel.

(73) Meril Limited (US)

(74) Cabinet ÉKÉMÉ LYSAGHT SARL, B.P. 6370, YAOUNDE (CM).

(57) The present invention provides an effective vaccine for marek's disease, which may be prepared using a recombinant marek's disease virus (MDV), strain CVI988, having been transformed with a foreign DNA construct that includes a long terminal repeat sequence of a reticuloendotheliosis virus. This safe viral agent elicits a highly protective immune response in a chicken against virulent MDV challenge without causing a significant degree of pathogenicity. Suitable formulations of the vaccine for use in chickens include an effective immunization dosage of this novel viral agent, along with a pharmaceutically acceptable carrier or diluent.



Fig. 1

[Consulter le mémoire](#)

(11) **17138**

(51) C07K 14/325; A01H 1/00; C12N 15/05

(21) 1201400446 - PCT/US13/035388

(22) 05.04.2013

(30) US n° 61/621436 du 06/04/2012

(54) Proteins toxic to hemipteran insect species.

(72) BAUM James A.,
EVDOKIMOV Artem G.,
MOSHIRI Farhad,
RYDEL Timothy J.,
STURMAN Eric J.,
VON RECHENBERG Moritz,
VU Halong,
WOLLACOTT Andrew M.,
ZHENG Meiyang.

(73) Monsanto Technology LLC (US)

(74) Cabinet ÉKÉMÉ LYSAGHT SARL, B.P. 6370, YAOUNDE (CM).

(57) The present invention discloses hemipteran insect inhibitory proteins, methods of using such proteins, nucleotide sequences encoding such proteins, methods of detecting and isolating such proteins, and their use in agricultural systems.

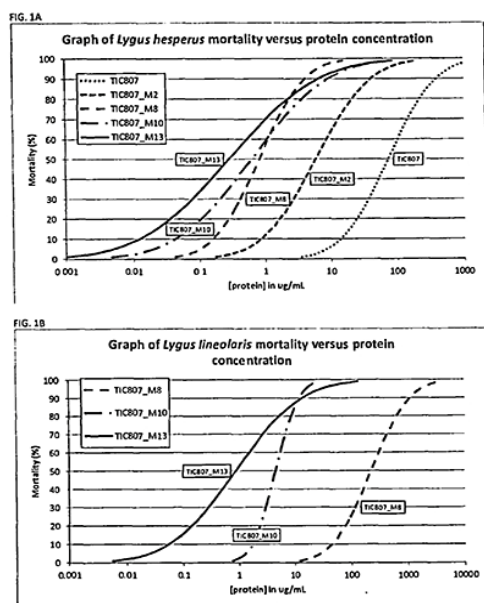

Fig. 1

[Consulter le mémoire](#)

(11) **17139**

(51) C07K 16/26; A61K 39/395; C07K 7/18
A61P 29/00

(21) 1201400447 - PCT/US13/031836

(22) 15.03.2013

(30) US n° 61/616 845 du 28/03/2012

FR n° 1350953 du 04/02/2013

(54) Antibodies to bradykinin B1 receptor ligands.

(72) LI Han,

KOMINOS Dorothea,

PRITSKER Alla,

DAVISON Matthew,

BAURIN Nicolas,

SUBRAMANIAN Govindan,

CHEN Xin,

ZHANG Jie.

(73) SANOFI (FR)

(74) Cabinet CAZENAVE SARL, B.P. 500,
YAOUNDE (CM).

(57) The disclosure provides antibodies that specifically bind to Kallidin or des-Arg 10-Kallidin. The disclosure also provides pharmaceutical compositions, as well as nucleic acids encoding anti-Kallidin or des- Arg10-Kallidin antibodies, recombinant expression vectors and host cells for making such antibodies, or fragments thereof. Methods of using antibodies of the disclosure to modulate Kallidin or des-Arg10- Kallidin activity or detect Kallidin or des-Arg10-Kallidin or, either in vitro or in vivo, are also provided by the disclosure. The disclosure further provides methods of making antibodies that specifically bind to des-Argg- Bradykinin and des-Arg10-Kallidin-like peptide.

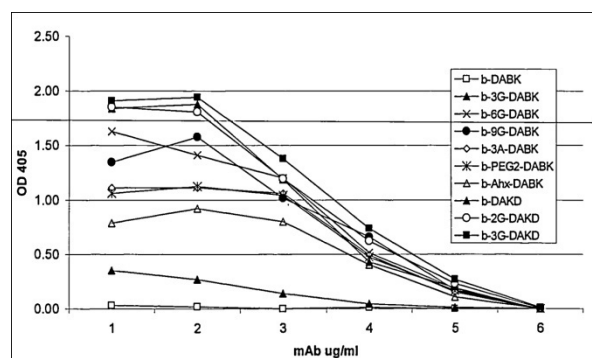

Fig. 1

[Consulter le mémoire](#)

(11) **17140**

(51) C07D 495/04; A61K 31/505; A61P 35/00

(21) 1201400458 - PCT/EP13/056958

(22) 02.04.2013

(30) FR n° 1253044 du 03/04/2012

(54) Novel thienopyrimidine derivatives, processes for the preparation thereof and therapeutic uses thereof.

(72) CARRY Jean-Christophe,

CHATREAU Fabienne,

DEPRETS Stéphanie,

DUCLOS Olivier,

LEROY Vincent,

MALLART Sergio,

MELON-MANGUER Dominique,

MENDEZ-PEREZ Maria,

VERGNE Fabrice.

(73) SANOFI (FR)

(74) Cabinet CAZENAVE SARL, B.P. 500, YAOUNDE (CM).

(57) The present invention relates to compounds of formula (I) :

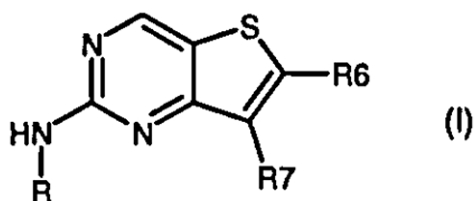

wherein R6 is -CONH₂ or a -C(R_α)(R_β)(OH) group; R is a substituted phenyl or heteroaryl group; R7 is an optionally substituted aryl or heteroaryl group. Process for the preparation thereof and therapeutic use thereof.

[Consulter le mémoire](#)

(11) **17141**

(51) C05F 9/04; C05F 17/00

(21) 1201400459 - PCT/IB13/000550

(22) 28.03.2013

(30) EP n° 12 002 508.5 du 05/04/2012

(54) Procédé de préparation de complexes végétaux activés et de complexes végétaux/matières organiques dopés ou surdopés, carbonatés, et leurs applications notamment en méthanisation ou fabrication de biogaz.

(72) MEZY Marcel Léon

(73) MEZY Marcel Léon (FR)

(74) Cabinet CAZENAVE SARL, B.P. 500, YAOUNDE (CM).

(57) L'invention concerne la préparation de complexes végétaux dopés par un procédé de fermentation d'un compost CP notamment de paille et de crottin de cheval fermenté 3-6 j, avec couverture par un complexe végétal carbonaté spécial CVC. On obtient un complexe végétal dopé ou surdopé à très forte concentration notamment en noyaux d'acides humiques, mycorhizes, gaz fixés (azote, carbone), présentant une activité biologique extrêmement améliorée avec une application dans l'amélioration de la méthanisation, jusqu'à 200-350 %.

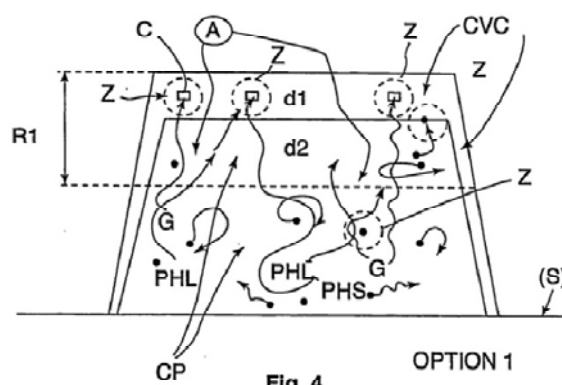

[Consulter le mémoire](#)

(11) **17142**

(51) A61K 45/06; A61K 31/44; A61P 35/00
A61K 35/519

(21) 1201400460 - PCT/US13/035231

(22) 04.04.2013

(30) US n° 61/621 252 du 06/04/2012

FR n° 1351158 du 12/02/2013

US n° 61/771 457 du 01/03/2013

(54) Methods for treating cancer using PI3K inhibitor and MEK inhibitor.

(72) HSU Karl,

LAGER Joanne,

OGDEN Janet Anne Meurer.

(73) SANOFI (FR);

MERCK PATENT GmbH (DE).

(74) Cabinet CAZENAVE SARL, B.P. 500, YAOUNDE (CM).

(57) Methods of treating patients with cancer are provided, wherein the methods comprise administering to the patient an effective amount of a MEK inhibitor and an effective amount of a PI3K inhibitor. Compositions in which the MEK and PI3K inhibitors are combined also are described.

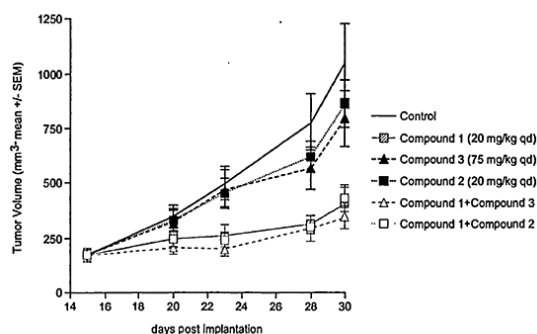

Fig. 1

[Consulter le mémoire](#)

(11) **17143**

(51) C07D 471/04; A61K 31/519; A61P 3/00

(21) 1201400461 - PCT/IB13/052404

(22) 26.03.2013

(30) US n° 61/621,144 du 06/04/2012

(54) Diacylglycerol acyltransferase 2 inhibitors.

(72) AHN, Kay,
BOEHM, Markus,
CABRAL, Shawn,
CARPINO, Philip A.,
FUTATSUGI, Kentaro,
HEPWORTH, David,
KUNG, Daniel W.,
ORR, Sui,
WANG, Jian.

(73) PFIZER INC. (US)

(74) SCP AKKUM, AKKUM & Associates,
Quartier Mballa II, Dragages, B.P. 4966,
YAOUNDE (CM).

(57) Derivatives of purine, 3H-imidazo[4,5-b]pyrimidine and 1H-imidazo[4,5-d]pyrazine of formula I that inhibit the activity of the diacylglycerol acyltransferase 2 (DGAT2) and their uses in the treatment of diseases linked thereto in animals are described herein.

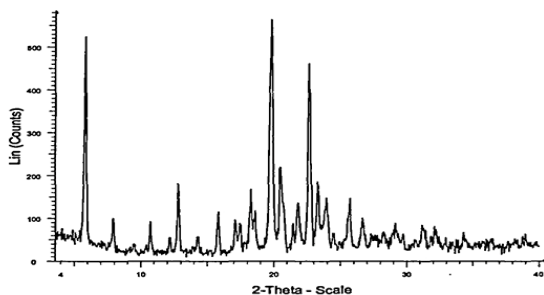

FIG. 1. X-ray powder diffraction pattern of Example 109-B.

Fig. 1

[Consulter le mémoire](#)

(11) **17144**

(51) C07D 403/12; C07D 401/12; A61P 3/04
A61P 35/00; A61P 3/10; C07D 209/42
C07D 231/56; A61K 31/404

(21) 1201400463 - PCT/IB13/052604

(22) 01.04.2013

(30) US n° 61/622,129 du 10/04/2012

(54) Indole and indazole compounds that activate ampk.

(72) BHATTACHARYA, Samit Kumar,
CAMERON, Kimberly O'Keefe,
DOWLING, Matthew Scott,
EBNER, David Christopher,
FERNANDO, Dilinie Prasadhini,
FILIPSKI, Kevin James,
KUNG, Daniel Wei-Shung,
LEE, Esther Cheng Yin,
SMITH, Aaron Christopher,
TU, Meihua Mike.

(73) PFIZER INC. (US)

(74) SCP AKKUM, AKKUM & Associates,
Quartier Mballa II, Dragages, B.P. 4966,
YAOUNDE (CM).

(57) The present invention relates to indole and indazole compounds of Formula (I)

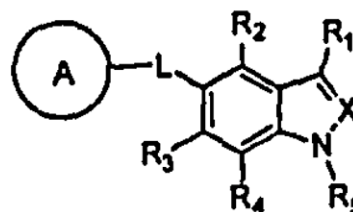

Formula (I)

That activate 5' adenosine monophosphate-activated protein kinase (AMPK). The invention also encompasses pharmaceutical compositions containing these compounds and methods for treating or preventing diseases, conditions, or disorders ameliorated by activation of AMPK.

[Consulter le mémoire](#)

(11) **17145**

(51) A61B 17/34

(21) 1201400470 - PCT/IB13/000649

(22) 10.04.2013

(30) IT n° BA2012U000020 du 11/04/2012

(54) Dual channel surgical device for abdomen access.

(72) NUZZIELLO Vincenzo, Via Lenotti 10, I-71122 FOGGIA (IT)

(73) NUZZIELLO Vincenzo, Via Lenotti 10, I-71122 FOGGIA (IT)

(74) Cabinet ÉKÉMÉ LYSAGHT SARL, B.P. 6370, YAOUNDE (CM).

(57) The patent concerns a trocar, that is a device to perform surgery using the laparoscopic technique. The trocar is equipped with a double channel allowing the simultaneous introduction of an optical instrument and a grasping or cutting instrument. Furthermore, the introduction of a movable two-way valve allows the rapid emptying of the abdomen or the removal of important anatomical pieces, if necessary.

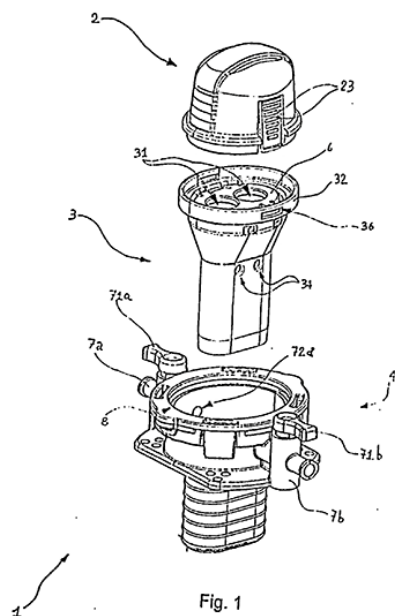

Fig. 1

[Consulter le mémoire](#)

(11) **17146**

(51) C07D 401/06; A61P 3/04; A61K 31/454

(21) 1201400473 - PCT/US13/037159

(22) 18.04.2013

(30) US n° 61/636,108 du 20/04/2012

(54) Methods of producing anamorelin hydrochloride having controlled chloride content.

(72) KUWABE, Shin-itsu;

YANAGIMACHI, Takehiko;

YOSHIYAMA, Hideyuki;

PINES, Seemon;

DE GROOT, Eleanor;

GARCIA RUBIO, Silvina;

MANINI, Peter.

(73) HELSINN HEALTHCARE SA (CH)

(74) SCP AKKUM, AKKUM & Associates, Quartier Mballa II, Dragages, B.P. 4966, YAOUNDE (CM).

(57) The present invention relates to particulate forms of anamorelin monohydrochloride or a composition comprising anamorelin monohydrochloride having controlled chloride content, preferably isolated in an amorphous and/or fine particulate state, processes for making the particulate forms, and pharmaceutical compositions comprising the particulate forms.

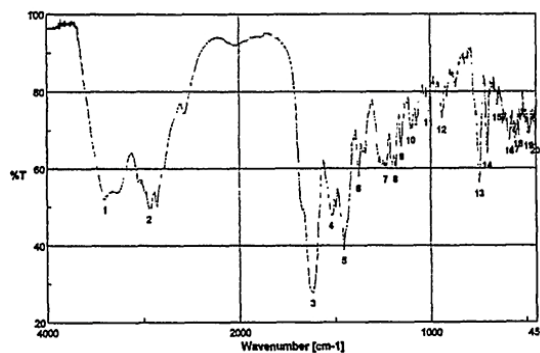

Fig. 2

[Consulter le mémoire](#)

(11) **17147**

(51) C12N 15/113; A61K 31/712; A61P 35/00
A61P 13/12; A61P 43/00

(21) 1201400479 - PCT/US13/037913

(22) 24.04.2013

(30) US n° 61/741,783 du 25/04/2012

US n° 61/717,927 du 24/10/2012

US n° 61/779,913 du 13/03/2013

(54) Microrna compounds and methods for modulating MIR-21 activity.

(72) BHAT, Balkrishen

MARCUSSON, Eric.

(73) Regulus Therapeutics Inc. (US)

(74) Cabinet Spoor & Fisher Inc. Ngwafor & Partners, Blvd. du 20 Mai, Immeuble Centre Commercial de l'Hôtel Hilton, 2è Etage, Porte 208A, B.P. 8211, YAOUNDE (CM).

(57) Described herein are compositions and methods for the inhibition of miR-21 activity. The compositions have certain nucleoside modification patterns that yield potent inhibitors of miR-21 activity. The compositions may be used to inhibit miR-21, and also to treat diseases associated with abnormal expression of miR-21, such as fibrosis and cancer.

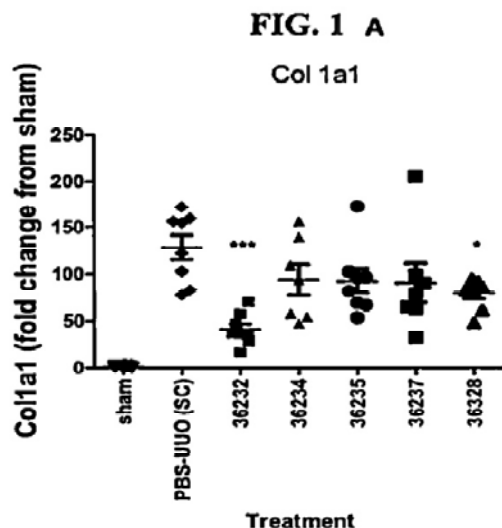

[Consulter le mémoire](#)

(11) **17148**

(51) C22B 3/42; C22B 3/00

(21) 1201400480 - PCT/US13/037673

(22) 23.04.2013

(30) US n° 61/640,925 du 01/05/2012

(54) Nickel and cobalt recovery using continuous ion exchange.

(72) EICHER, Christopher R.;

MARSTON, Charles R.

(73) Dow Global Technologies LLC (US)

(74) Cabinet Spoor & Fisher Inc. Ngwafor & Partners, Blvd. du 20 Mai, Immeuble Centre Commercial de l'Hôtel Hilton, 2è Etage, Porte 208A, B.P. 8211, YAOUNDE (CM).

(57) A method for recovering nickel and cobalt from a product liquor solution by processing the product liquor solution through a continuous ion exchange process including a plurality of ion exchange beds containing nickel selective ion exchange resin that pass through individual process zones as part of a nickel recovery circuit, wherein the method includes the following steps : (a) passing the product liquor solution through an ion exchange bed to load nickel onto the ion

exchange resin and produce a cobalt-containing raffinate solution, (b) passing a sulfuric acid solution through the loaded ion exchange bed to strip nickel from the ion exchange resin and produce a nickel-containing eluate, (c) passing a rinse solution through the stripped ion exchange bed, (d) adjusting the pH of the cobalt-containing raffinate solution to a pH of at least 2.3, (e) passing the cobalt-containing raffinate solution through an ion exchange bed to pre-load cobalt on the ion exchange resin, (f) repeating step (a) though (e) until the cobalt concentration of the cobalt-containing raffinate solution increases to at least twice that of the product liquor solution, and (g) removing a first portion of the cobalt-containing raffinate solution of step (d) from the nickel recovery circuit for subsequent cobalt recovery, and (h) passing a second portion of the cobalt-containing raffinate solution from step (d) to step (e).

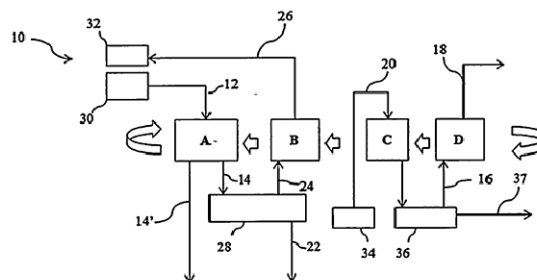

Fig. 1

[Consulter le mémoire](#)

(11) **17149**

(51) A01N 43/653; A01N 43/84; A01N 43/56

(21) 1201400482 - PCT/US13/029608

(22) 07.03.2013

(30) US n° 61/639,274 du 27/04/2012

(54) Pesticidal compositions and processes related thereto.

(72) HUNTER, Ricky;

BUYSSE, Ann M.;

NIYAZ, Noormohamed M.;

ZHANG, Yu;

WALSH, Martin J.;

KUBOTA, Asako;

TRULLINGER, Tony K.;

PATNY, Akshay;

GARIZI, Negar;
 LOWE, Christian T.;
 KNUEPPEL, Daniel;
 DEMETER, David A.;
 LEPLAE, Paul Renee;
 WESSELS, Frank.

(73) Dow AgroSciences LLC (US)

(74) Cabinet Spoor & Fisher Inc. Ngwafor & Partners, Blvd. du 20 Mai, Immeuble Centre Commercial de l'Hôtel Hilton, 2è Etage, Porte 208A, B.P. 8211, YAOUNDE (CM).

(57) This document discloses molecules having the formula (I)

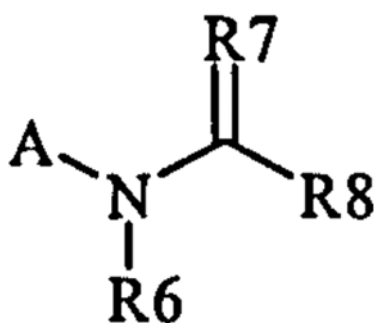

and processes related thereto.

[Consulter le mémoire](#)

(11) **17150**

(51) H04L 29/06 (06.01)

(21) 1201400485 - PCT/CN13/075015

(22) 28.04.2013

(30) CN n° 201210137255.3 du 04/05/2012

(54) Method, server, user terminal, and system for data presentation in multi-person conversation.

(72) GE, Xiangwei.

(73) TENCENT TECHNOLOGY (SHENZHEN) COMPANY LIMITED (CN)

(74) SCP AKKUM, AKKUM & Associates, Quartier Mballa II, Dragages, B.P. 4966, YAOUNDE (CM).

(57) The present disclosure discloses a method, server, client and system for data presentation in a multiplayer session, and belongs to the technical field of multiplayer video session. The method includes: establishing a session connection with multiple clients participating in the session; receiving session control commands,

audio data and video data transmitted by the multiple clients participating in the session through the session connection; assigning audio data and video data to the first client based on the session control commands transmitted by the multiple clients participating in the session, the first client is any one of the multiple clients participating in the session; transmitting the audio data and video data to the first client, so as for the first client to present the audio data and video data. Thus the audio data and video data assigned to the clients are controlled, which can reduce the dependence on network bandwidth, save network traffic, and reduce the performance requirements on the clients, so that the multiplayer session can cover more users.

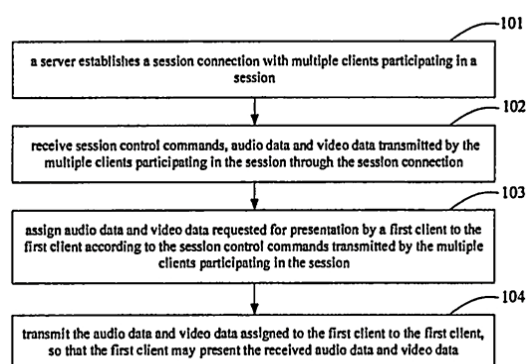

Fig. 1

[Consulter le mémoire](#)

(11) **17151**

(51) C05C 9/00; B01J 2/00; C07C 273/16

(21) 1201400492 - PCT/EP13/001292

(22) 02.05.2013

(30) EP n° 12003585.2 du 08/05/2012

(54) Urea granulation process with scrubbing system.

(72) POTTHOFF, Matthias;

FRANZRAHE, Harald;

VANMARCKE, Luc.

(73) Uhde Fertilizer Technology B.V. (NL)

(74) Cabinet Spoor & Fisher Inc. Ngwafor & Partners, Blvd. du 20 Mai, Immeuble Centre Commercial de l'Hôtel Hilton, 2è Etage, Porte 208A, B.P. 8211, YAOUNDE (CM).

(57) Urea granulation process with scrubbing system including at least one gaseous waste stream for removal of dust and ammonia whereby

this waste stream is processed through a combination of the following process steps comprising: (a) washing the dust and ammonia laden stream (4) with water and/or an aqueous urea solution whereby a dust-laden liquid stream (26) and a dust-reduced stream (5) is generated, and (b) reacting the dust-reduced stream (5) with formaldehyd (7) to form a stream (8) comprising hexamethylenetetramine and urea-formaldehyde and clean off-gas (6) wherein the gas stream is directed first through process step (a) and then through process step (b).

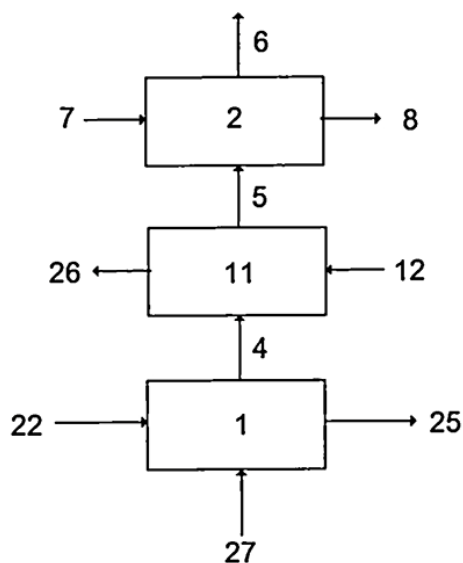

Fig. 1

[Consulter le mémoire](#)

(11) **17152**

(51) C10G 1/00; G05D 21/02

(21) 1201400495 - PCT/US13/038761

(22) 30.04.2013

(30) US n° 61/645,094 du 10/05/2012

(54) Methods for expanding and enriching hydrocarbon diluent pools.

(72) MATTINGLY, Larry, D.;
ANDREWS, Ronnie.

(73) TEXON LP (US)

(74) SCP AKKUM, AKKUM & Associates, Quartier Mballa II, Dragages, B.P. 4966, YAOUNDE (CM).

(57) The invention provides a method for enriching diluents with butane so as not to violate pre-defined limits for liquid hydrocarbon fuels with

respect to density, volatility and low density hydrocarbon content.

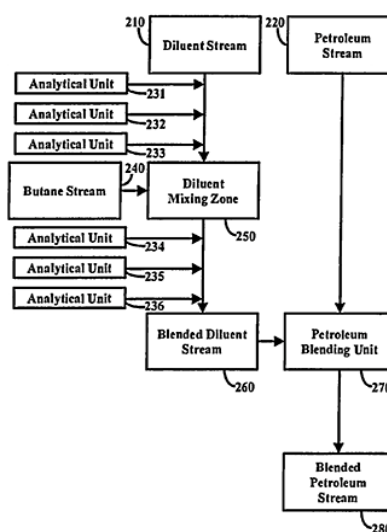

Fig. 2

[Consulter le mémoire](#)

(11) **17153**

(51) C07H 19/11; A61K 31/7072; A61P 31/14

(21) 1201400515 - PCT/EP13/060704

(22) 24.05.2013

(30) EP n° 12169425.1 du 25/05/2012

(54) Uracyl spirooxetane nucleosides.

(72) HOUPIS, Ioannis Nicolaos;
JONCKERS, Tim Hugo Maria;
RABOISSON, Pierre Jean-Marie Bernard;
TAHRI, Abdellah.

(73) JANSSEN R&D IRELAND (IE)

(74) SCP AKKUM, AKKUM & Associates, Quartier Mballa II, Dragages, B.P. 4966, YAOUNDE (CM).

(57) The present invention relates to compounds of the formula I :

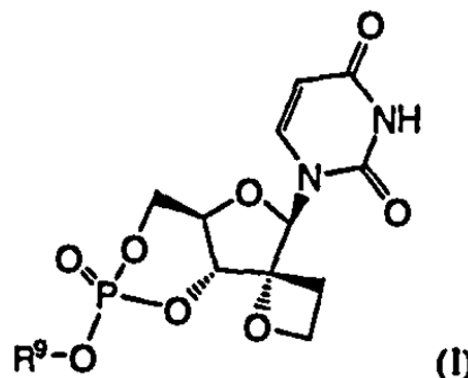

including any possible stereoisomers thereof, wherein R⁹ has the meaning as defined herein, or a pharmaceutically acceptable salt or solvate thereof. The present invention also relates to processes for preparing said compounds, pharmaceutical compositions containing them and their use, alone or in combination with other HCV inhibitors, in HCV therapy.

[Consulter le mémoire](#)

(11) **17154**

(51) A61K 31/343; A61P 33/02

(21) 1201400516 - PCT/EP13/060513

(22) 22.05.2013

(30) US n° 61/650 182 du 22/05/2012
EP n° 12306362.0 du 31/10/2012
EP n° 12306472.7 du 28/11/2012

(54) Dronedarone for use in leishmaniasis, formulations and associations for use in leishmaniasis.

(72) BEILLES Stéphane;
CHAMBONNET Sandra;
COLLAVERI Jean-Pierre.

(73) SANOFI (FR)

(74) Cabinet CAZENAVE SARL, B.P. 500, YAOUNDE (CM).

(57) The invention relates to dronedarone or one of its pharmaceutically acceptable salts for the treatment of leishmaniasis, formulations and associations comprising dronedarone or one of its pharmaceutically acceptable salts for the treatment of leishmaniasis.

[Consulter le mémoire](#)

(11) **17155**

(51) C10L 1/08; C10L 1/10; F02B 3/08
F02B 49/00; F02B 51/00

(21) 1201400520 - PCT/AU13/000555

(22) 24.05.2013

(30) AU n° 2012902180 du 25/05/2012

(54) Methods for the preparation and delivery of fuel compositions.

(72) MORRIS, Greg

(73) Gane Energy & Resources Pty Ltd (AU)

(74) Cabinet Spoor & Fisher Inc. Ngwafor & Partners, Blvd. du 20 Mai, Immeuble Centre Commercial de l'Hôtel Hilton, 2è Etage, Porte 208A, B.P. 8211, YAOUNDE (CM).

(57) A process for generating a main fuel composition comprising methanol and water and not more than 20% by weight dimethyl ether, and a fumigant comprising dimethyl ether, the process comprising: - providing a pre-fuel composition comprising methanol and dimethyl ether, - adding water to the pre-fuel composition to cause or aid evaporation of at least a portion of the dimethyl ether from the pre-fuel composition, - collecting the portion of dimethyl ether evaporated from the pre-fuel composition for use as a fumigant, and - using the remainder of the pre-fuel composition comprising methanol and water as a main fuel composition. The water may be at a temperature above ambient.

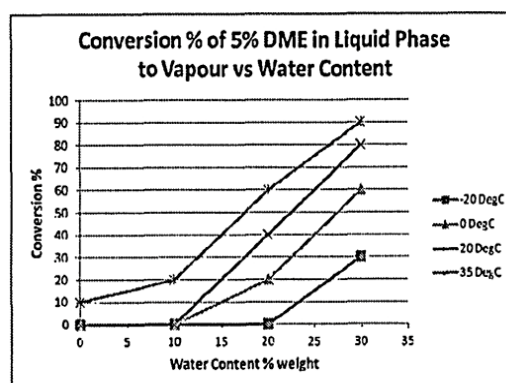

Fig. 1

[Consulter le mémoire](#)

(11) **17156**

(51) A23L 3/00

(21) 1201400564 - PCT/MY13/000119

(22) 28.06.2013

(30) MY n° PI 2012003015 du 03/07/2012

(54) Installation for treatment of oil palm fruits.

(72) LEW Heng Mun

(73) LEW Heng Mun (MY)

(74) Cabinet ÉKÉMÉ LYSAGHT SARL, B.P. 6370, YAOUNDE (CM).

(57) An installation for treatment of harvested palm fruits using pressurized steam comprises a sterilizer unit and a steam supply unit working in combination. The sterilizer unit includes a vessel

(10) having inlet (12) for charging in fruits, steam openings (16a, 16b, 16c) for receiving steam, outlet (14) for dispensing treated fruits and a pivot (20) for tilting the vessel to various orientations. The steam supply unit includes a shaft (28) fixedly mounted onto the pivot (20), a pipeline (30) connected to end of the shaft and used for supplying steam, a housing (32) connected to and rotatable about the pipeline, a flange (38) to retain the housing in position, and an elbow (54) connected to the housing such that the elbow can supply steam to the vessel from a fixed location.

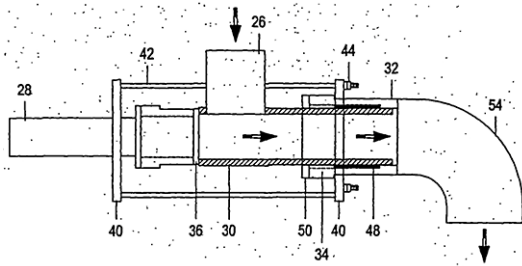

Fig. 4

[Consulter le mémoire](#)

(11) **17157**

(51) A61K 33/04; A61P 13/00; A61K 45/06
A61K 35/74; A61P 15/02; A61P 31/10
C12N 1/20

(21) 1201500003 - PCT/EP13/064451

(22) 09.07.2013

(30) FR n° 1256570 du 09/07/2012

(54) Utilisation de thiosulfate pour potentialiser l'effet anti-pathogène des lactobacilles.

(72) NIVOLIEZ Adrien

(73) PROBIONOV (FR)

(74) Cabinet CAZENAVE SARL, B.P. 500, YAOUNDE (CM).

(57) La présente invention concerne l'utilisation de thiosulfate pour potentialiser l'effet anti-pathogène de bactéries lactobacilles, le thiosulfate étant en quantité d'au moins 100 mg pour 10^7 à 10^{10} UFC de lactobacilles. L'invention concerne également une composition pharmaceutique comprenant au moins 100 mg de thiosulfate par gramme, en association avec une souche de *Lactobacillus crispatus*, ainsi que son utilisation dans le traitement d'infections urogénitales telles que les vaginoses, les candidoses et les infections urinaires.

[Consulter le mémoire](#)

(11) **17158**

(51) C25C 7/04; C25C 1/10

(21) 1201500004 - PCT/IB12/001776

(22) 09.07.2012

(54) Internal frame assembly of a cell for electrolysis of manganese, associated cell and method.

(72) LI Tiejing;

ALBERT Luc.

(73) ERAMET (FR)

(74) Cabinet CAZENAVE SARL, B.P. 500, YAOUNDE (CM).

(57) The cell comprises a plurality of anode frames, a plurality of cathode frames (64) and a plurality of diaphragms (68) interposed between each cathode frame (64) and each anode frame (66). At least one diaphragm (68) comprises a first porous wall (106A) covering a first axial opening (105A) of a cathode frame (64), a second porous wall (106B) covering the second axial opening (105B) of the cathode frame (64) and at least a connecting wall (108C, 108D) connecting the first porous wall (106A) and the second porous wall (106B) along the cathode frame (64), the first porous wall (106A), the second porous wall (106B) and the connecting wall (108C, 108D) defining an internal space (109) containing or defining the internal cathode receiving compartment (90).

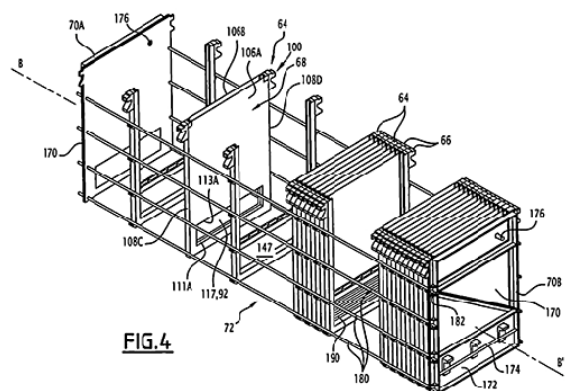

[Consulter le mémoire](#)

(11) **17159**

(51) A01N 43/40; C12N 9/00

(21) 1201500005 - PCT/JP13/069081

(22) 08.07.2013

(30) JP n° 2012-153986 du 09/07/2012

(54) UK-2 biosynthetic genes and method for improving UK-2 productivity using the same.

(72) KOBAYASHI, Koei;
SUMIDA, Naomi;
YANAI, Koji.

(73) Meiji Seika Pharma Co., Ltd. (JP)

(74) Cabinet Spoor & Fisher Inc. Ngwafor & Partners, Blvd. du 20 Mai, Immeuble Centre Commercial de l'Hôtel Hilton, 2è Etage, Porte 208A, B.P. 8211, YAOUNDE (CM).

(57) To provide a production method capable of mass production of UK-2 at low cost, the genomic DNA of *Streptovercillium* sp. 3-7, which produces UK-2, was analyzed to identify a region expected to be a UK-2 biosynthetic gene cluster. Moreover, by colony hybridization, DNAs in the region were successfully isolated. Further, the DNAs were used to prepare a strain in which the genes present in the region were disrupted. The strain was found not to produce UK-2. It was verified that the genomic region was the UK-2 biosynthetic gene cluster. Furthermore, *Streptovercillium* sp. 3-7 was transformed by introduction of a vector in which the isolated UK-2 biosynthetic gene cluster was inserted. It was also found out that the UK-2 productivity by the transformant was improved about 10 to 60 times or more in comparison with that of the parental strain. Moreover, it was revealed that 2 copies of the UK-2 biosynthetic gene cluster were present per cell in these transformants, respectively.

[Consulter le mémoire](#)

(11) **17160**

(51) C07D 471/14; A61P 25/10; A61K 31/4985

(21) 1201500009 - PCT/EP13/065894

(22) 29.07.2013

(30) EP n° 12178713.9 du 31/07/2012

(54) 4-methyl-2,3,5,9b-pentaza-cyclopenta[a]-naphthalenes.

(72) GIOVANNINI Riccardo;
BERTANI Barbara;
FRATTINI Sara;
DI ANTONIO Giustino;
LANKAU Hans-Joachim;
STANGE Hans;

GRUNWALD Christian;

HÖFGEN Norbert;

LANGEN Barbara;

EGERLAND Ute.

(73) Boehringer Ingelheim International GmbH (DE)

(74) Cabinet ÉKÉMÉ LYSAGHT SARL, B.P. 6370, YAOUNDE (CM).

(57) The invention relates to 4-methyl-2,3,5,9b-pentaza-cyclopenta[a]naphthalenes derivatives of general formula (I)

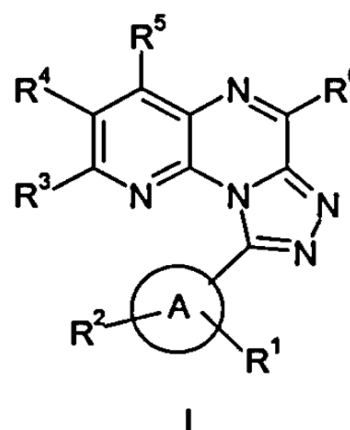

which are inhibitors of phosphodiesterase 2 and/or 10, useful in treating central nervous system diseases and other diseases. In addition, the invention relates to processes for preparing pharmaceutical compositions as well as processes for manufacture the compounds according to the invention.

[Consulter le mémoire](#)

(11) **17161**

(51) C07D 401/14; C07D 405/14; C07D 413/14

C07D 231/38; C07D 417/02; C07D 277/56

A61P 19/00; A61P 11/00

(21) 1201500010 - PCT/US13/054096

(22) 08.08.2013

(30) US n° 61/681684 du 10/08/2012

(54) Heteroaromatic compounds as bruton's tyrosine kinase (BTK) inhibitors.

(72) BENTZIEN Joerg Martin;
BERRY Angela Kay;
BOSANAC Todd;
BURKE Michael Jason;

DISALVO Darren Todd;
 HORAN Joshua Courtney;
 LIANG Shuang;
 MAO Can;
 SHEN Yue;
 SOLEYMANZADEH Fariba;
 ZINDELL Renee M.

(73) Boehringer Ingelheim International GmbH
 (DE)

(74) Cabinet ÉKÉMÉ LYSAGHT SARL,
 B.P. 6370, YAOUNDE (CM).

(57) The present invention encompasses
 compounds of the formula (I)

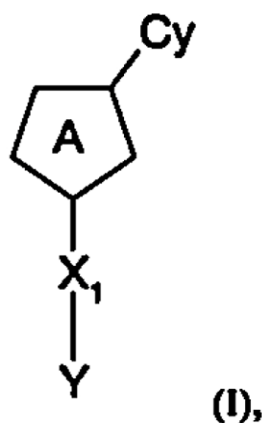

wherein the groups A, Cy, X₁ and Y are defined herein, which are suitable for the treatment of a disease chosen from rheumatoid arthritis, systemic lupus erythromatosis, scleroderma, asthma, allergic rhinitis, allergic eczema, B cell lymphoma, multiple sclerosis, juvenile rheumatoid arthritis, juvenile idiopathic arthritis, inflammatory bowel disease, graft versus host disease, psoriatic arthritis, ankylosing spondylitis and uveitis.

[Consulter le mémoire](#)

(11) **17162**

(51) F01K 13/00; H01L 35/28; F01K 25/00

(21) 1201500014 - PCT/IB13/056029

(22) 23.07.2013

(30) EP n° 12178430.0 du 30/07/2012

(54) Process producing useful energy from
 thermal energy.

(72) Cohen, Yoav

(73) Cohen, Yoav (CH)

(74) Cabinet Spoor & Fisher Inc. Ngwafor &
 Partners, Blvd. du 20 Mai, Immeuble Centre
 Commercial de l'Hôtel Hilton, 2^e Etage, Porte
 208A, B.P. 8211, YAOUNDE (CM).

(57) The invention relates to a process producing
 useful energy from thermal energy. An overall
 population of mobile particles confined to a
 unidirectional flow closed circuit of conducting
 channels (1-2-3-3'-4-1) is subjected to a
 conservative or effectively conservative force field.
 The circuit is thermally insulated with the
 exception of two non juxtaposed areas a first area
 (2-3) allowing thermal exchange for heating (Q_{in})
 from a warmer environment outside the circuit, a
 second area (4-1) allowing thermal exchange
 (Q_{out}) for cooling, as necessary, by a colder
 environment outside the circuit. The closed circuit
 is provided with a load (3'-4;) designed to convert
 the energy it receives from the mobile particles
 flow to a useful output energy. In two portions of
 the unidirectional circuit located before (3-3')
 and after (1-2;) said load, flow velocity vector
 is parallel or has a component which is parallel
 to the conservative or effectively conservative
 force field one portion with a warm flow and
 the other portion with a cool flow of mobile
 particles and in that if the density of the chosen
 mobile particles decreases when the temperature
 increases, the direction of the conservative
 force field is the same as that of the cool
 flow velocity vector or of a cool flow velocity
 vector component in the said circuit portion
 and the inverse if the density of the chosen
 mobile particles increases when the
 temperature increases.

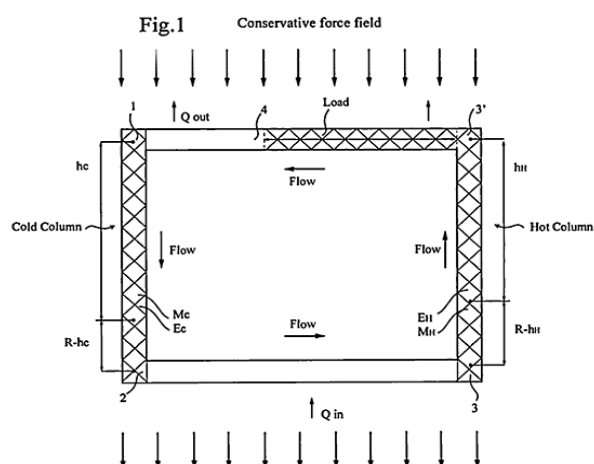

[Consulter le mémoire](#)

(11) 17163

(51) B01J 23/34; B01J 21/04; B09C 1/10
B01J 37/00

(21) 1201500019 - PCT/FR13/051772

(22) 23.07.2013

(54) Utilisation de certaines plantes accumulatrices de manganèse pour la mise en oeuvre de réactions de chimie organique.

(72) GRISON Claude;
ESCANDE Vincent.

(73) CENTRE NATIONAL DE LA RECHERCHE SCIENTIFIQUE (FR)

UNIVERSITE MONTPELLIER 2 SCIENCES ET TECHNIQUES (FR).

(74) Cabinet CAZENAVE SARL, B.P. 500, YAOUNDE (CM).

(57) L'invention concerne l'utilisation, après traitement thermique, de plantes accumulatrices de manganèse pour la mise en oeuvre de réactions chimiques.

[Consulter le mémoire](#)

(11) 17164

(51) A01N 43/40

(21) 1201500029 - PCT/US13/051307

(22) 19.07.2013

(30) US n° 61/675,056 du 24/07/2012
US n° 13/833,315 du 15/03/2013

(54) Herbicidal compositions comprising 4-amino-3-chloro-5-fluoro-6-(4-chloro-2-fluoro-3-methoxyphenyl) pyridine-2-carboxylic acid.

(72) YERKES, Carla, N.;
MANN, Richard, K.

(73) Dow AgroSciences LLC (US)

(74) Cabinet Spoor & Fisher Inc. Ngwafor & Partners, Blvd. du 20 Mai, Immeuble Centre Commercial de l'Hôtel Hilton, 2è Etage, Porte 208A, B.P. 8211, YAOUNDE (CM).

(57) Provided herein are synergistic herbicidal compositions containing (a) a compound of formula (I)

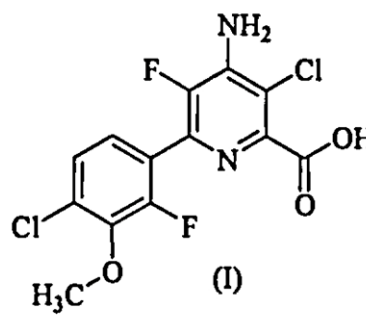

or an agriculturally acceptable salt or ester thereof and (b) clomazone. The compositions and methods provided herein control undesirable vegetation, e.g., in direct-seeded, water-seeded and transplanted rice, cereals, wheat, barley, oats, rye, sorghum, corn/maize, sugarcane, sunflower, oilseed rape, canola, sugar beet, soybean, cotton, pineapple, pastures, grasslands, rangelands, fallowland, turf, tree and vine orchards, aquatics, plantation crops, vegetables, industrial vegetation management (IVM) and rights of way (ROW).

[Consulter le mémoire](#)

(11) 17165

(51) C07D 401/14; A61P 13/00; A61K 31/4439
A61P 25/00; A61P 9/00; A61P 3/00

(21) 1201500034 - PCT/US13/057826

(22) 03.09.2013

(30) US n° 61/697899 du 07/09/2012

(54) Alkoxy pyrazoles as soluble guanylate cyclase activators.

(72) BRENNEMAN Jehrod Burnett;
GINN John David;
LOWE Michael D.;
SARKO Christopher Ronald;
TASBER Edward S.;
ZHANG Zhonghua.

(73) Boehringer Ingelheim International GmbH (DE)

(74) Cabinet ÉKÉMÉ LYSAGHT SARL, B.P. 6370, YAOUNDE (CM).

(57) The present invention relates to compounds of formula (I) :

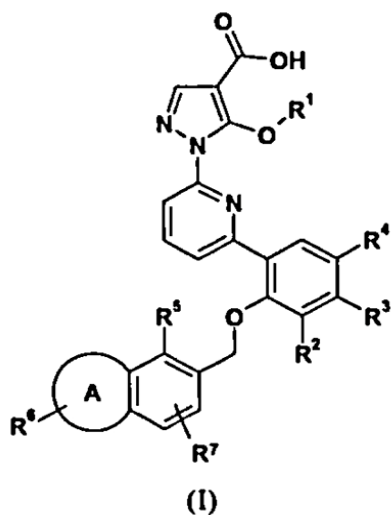

(I)

and pharmaceutically acceptable salts thereof, wherein R¹, R², R³, R⁴, R⁵, R⁶ and R⁷ are as defined herein. The invention also relates to pharmaceutical compositions comprising these compounds, methods of using these compounds in the treatment of various diseases and disorders, processes for preparing these compounds and intermediates useful in these processes.

[Consulter le mémoire](#)

B
REPertoire SUIVANT LA C.I.B.

(11)	(51)
17118	A01N 43/40
17159	A01N 43/40
17164	A01N 43/40
17149	A01N 43/653
17122	A01N 65/00
17156	A23L 3/00
17132	A61B 10/00
17145	A61B 17/34
17119	A61F 2/04
17120	A61F 2/04
17154	A61K 31/343
17116	A61K 31/407
17131	A61K 31/704
17135	A61K 31/7068
17125	A61K 33/00
17157	A61K 33/04
17137	A61K 39/255
17117	A61K 39/395
17126	A61K 39/395
17142	A61K 45/06
17163	B01J 23/34
17127	C02F 1/42
17134	C02F 1/66
17130	C04B 7/13
17151	C05C 9/00
17141	C05F 9/04
17124	C07D 311/36
17146	C07D 401/06
17161	C07D 401/14
17165	C07D 401/14
17144	C07D 403/12
17136	C07D 405/14
17133	C07D 471/04
17143	C07D 471/04
17160	C07D 471/14
17123	C07D 473/34
17121	C07D 491/08
17140	C07D 495/04
17153	C07H 19/11

(11)	(51)
17138	C07K 14/325
17139	C07K 16/26
17152	C10G 1/00
17155	C10L 1/08
17147	C12N 15/113
17148	C22B 3/42
17158	C25C 7/04
17129	E01B 9/30 (06.01)
17162	F01K 13/00
17128	F16L 15/04 (06.01)
17150	H04L 29/06 (06.01)

C
REPertoire DES NOMS

ALIOS BIOPHARMA, INC.
(11) 17135 (51) A61K 31/7068
AYISSI Charles
(11) 17122 (51) A01N 65/00
BIGNOTTI, Andrea and TURELLI, Chiara
(11) 17125 (51) A61K 33/00
Boehringer Ingelheim International GmbH
(11) 17136 (51) C07D 405/14
(11) 17160 (51) C07D 471/14
(11) 17161 (51) C07D 401/14
(11) 17165 (51) C07D 401/14
Cadila Healthcare Limited
(11) 17126 (51) A61K 39/395
CENTRE NATIONAL DE LA RECHERCHE SCIENTIFIQUE et UNIVERSITE MONTPELLIER 2 SCIENCES ET TECHNIQUES
(11) 17163 (51) B01J 23/34
Cohen, Yoav
(11) 17162 (51) F01K 13/00
Dow AgroSciences LLC
(11) 17149 (51) A01N 43/653
(11) 17164 (51) A01N 43/40
Dow Global Technologies LLC
(11) 17148 (51) C22B 3/42
ERAMET
(11) 17158 (51) C25C 7/04
Gane Energy & Resources Pty Ltd
(11) 17155 (51) C10L 1/08
Gilead Biologics, Inc.
(11) 17117 (51) A61K 39/395
Gilead Calistoga LLC
(11) 17123 (51) C07D 473/34
HELSINN HEALTHCARE SA
(11) 17146 (51) C07D 401/06
INDJENDJET GONDJOUT Franck Dilard Paul
(11) 17132 (51) A61B 10/00
JANSSEN R&D IRELAND
(11) 17153 (51) C07H 19/11

LEW Heng Mun
(11) 17156 (51) A23L 3/00
Lupin Limited
(11) 17133 (51) C07D 471/04
Meiji Seika Pharma Co., Ltd.
(11) 17118 (51) A01N 43/40
(11) 17159 (51) A01N 43/40
Merial Limited
(11) 17137 (51) A61K 39/255
MEZY Marcel Léon
(11) 17141 (51) C05F 9/04
MINTAILS MINING SA (PTY) LIMITE
(11) 17134 (51) C02F 1/66
Monsanto Technology LLC
(11) 17138 (51) C07K 14/325
NAOUNOU Tapé Luc (M.)
(11) 17127 (51) C02F 1/42
Nippon Steel & Sumitomo Metal Corporation and Vallourec Oil and Gas France
(11) 17128 (51) F16L 15/04 (06.01)
NUZZIELLO Vincenzo
(11) 17145 (51) A61B 17/34
PFIZER INC.
(11) 17116 (51) A61K 31/407
(11) 17121 (51) C07D 491/08
(11) 17143 (51) C07D 471/04
(11) 17144 (51) C07D 403/12
PROBIONOV
(11) 17157 (51) A61K 33/04
Procedo Enterprises Etablissement
(11) 17130 (51) C04B 7/13
Regulus Therapeutics Inc.
(11) 17147 (51) C12N 15/113
Rhizen Pharmaceuticals SA
(11) 17124 (51) C07D 311/36
Sambusseti, Antonio
(11) 17119 (51) A61F 2/04
(11) 17120 (51) A61F 2/04

SANOFI		
(11)	17131	(51) A61K 31/704
(11)	17139	(51) C07K 16/26
(11)	17140	(51) C07D 495/04
(11)	17154	(51) A61K 31/343
SANOFI and MERCK PATENT GmbH		
(11)	17142	(51) A61K 45/06
TENCENT TECHNOLOGY (SHENZHEN) COMPANY LIMITED		
(11)	17150	(51) H04L 29/06 (06.01)
TEXON LP		
(11)	17152	(51) C10G 1/00
Uhde Fertilizer Technology B.V.		
(11)	17151	(51) C05C 9/00
VOSSLOH-WERKE GMBH		
(11)	17129	(51) E01B 9/30 (06.01)