

Bulletin Officiel de la Propriété Industrielle (BOPI)

Dessins et modèles industriels

PUBLICATION

N° 10 DM / 2014

du 09 Octobre 2015

Organisation
Africaine de la
Propriété
Intellectuelle



SOMMAIRE

TITRE	PAGES
PREMIERE PARTIE : GENERALITES	2
Extrait de la norme ST3 de l'OMPI utilisée pour la représentation des pays et organisations internationales	3
Extrait de la norme ST. 80 de l'OMPI utilisée en matière de documentation de Dessins et Modèles Industriels	6
Codes utilisés en matière de Dessins et Modèles Industriels Renouvelés	6
Classification Internationale des Dessins et Modèles Industriels en vertu de l'Arrangement de LOCARNO du 08 Octobre 1968 (9 ^e édition)	7
Clarification du Règlement relatif à l'Extension des Droits suite à une nouvelle Adhésion à l'Accord de Bangui	9
Adresses utiles	10
DEUXIEME PARTIE : DESSINS ET MODELES INDUSTRIELS	11
Dessins et Modèles Industriels du N° 04326 au N° 04370	12

**PREMIERE PARTIE
GENERALITES**

Extrait de la norme ST.3 de l'OMPI

Code normalisé à deux lettres recommandé pour la représentation des pays ainsi que d'autres entités et des organisations internationales délivrant ou enregistrant des titres de propriété industrielle.

Afghanistan	AF	Cook, Îles	CK
Afrique du Sud	ZA	Corée (République de Corée)	KR
Albanie	AL	Corée (Rép. Populaire de Corée)	KP
Algérie	DZ	Costa Rica	CR
Allemagne	DE	Côte d'Ivoire*	CI
Andorre	AD	Croatie	HR
Angola	AO	Cuba	CU
Anguilla	AI	Danemark	DK
Antigua-et-Barbuda	AG	Djibouti	DJ
Antilles Néerlandaises	AN	Dominicaine, République	DO
Arabie Saoudite	SA	Dominique	DM
Argentine	AR	Egypte	EG
Arménie	AM	El Salvador	SV
Aruba	AW	Emirats Arabes Unis	AE
Australie	AU	Equateur	EC
Autriche	AT	Erythrée	ER
Azerbaïdjan	AZ	Espagne	ES
Bahamas	BS	Estonie	EE
Bahreïn	BH	Etats-Unis d'Amérique	US
Bangladesh	BD	Ethiopie	ET
Barbade	BB	Ex Rep. Yougoslavie de Macedoine	MK
Bélarus	BY	Falkland, Îles (Malvinas)	FK
Belgique	BE	Fédération de Russie	RU
Belize	BZ	Fidji	FJ
Bénin*	BJ	Féroé, Îles	FO
Bermudes	BM	Finlande	FI
Bhoutan	BT	France	FR
Bolivie	BO	Gabon*	GA
Bonaire, Saint-Eustache et Saba	BQ	Gambie	GM
Bosnie-Herzégovine	BA	Géorgie	GE
Botswana	BW	Géorgie du Sud et les Îles Sandwich du Sud	GS
Bouvet, Île	BV	Ghana	GH
Brésil	BR	Gibraltar	GI
Brunéi Darussalam	BN	Grèce	GR
Bulgarie	BG	Grenade	GD
Burkina Faso*	BF	Groenland	GL
Burundi	BI	Guatemala	GT
Caïmanes, Îles	KY	Guernesey	GG
Cambodge	KH	Guinée*	GN
Cameroun*	CM	Guinée-Bissau*	GW
Canada	CA	Guinée Equatoriale*	GQ
Cap-Vert	CV	Guyana	GY
Centrafricaine, République*	CF	Haïti	HT

Chili	CL	Honduras	HN
Chine	CN	Hong Kong	HK
Chypre	CY	Hongrie	HU
Colombie	CO	Île de Man	IM
Comores*	KM	Îles Vierges (Britanniques)	VG
Congo*	CG	Inde	IN
Congo(Rép.Démocratique)	CD	Indonésie	ID
Iran(République Islamique d')	IR	Norvège	NO
Iraq	IQ	Nouvelle-Zélande	NZ
Irlande	IE	Oman	OM
Islande	IS	Ouganda	UG
Israël	IL	Ouzbékistan	UZ
Italie	IT	Pakistan	PK
Jamaïque	JM	Palaos	PW
Japon	JP	Panama	PA
Jersey	JE	Papouasie-Nouvelle-Guinée	PG
Jordanie	JO	Paraguay	PY
Kazakhstan	KZ	Pays-Bas	NL
Kenya	KE	Pérou	PE
Kirghizistan	KG	Philippines	PH
Kiribati	KI	Pologne	PL
Koweït	KW	Portugal	PT
Laos	LA	Qatar	QA
Lesotho	LS	Région admin. Spéciale de Hong Kong (Rep. Populaire de Chine)	HK
Lettonie	LV	Roumanie	RO
Liban	LB	Royaume Uni (Grande Bretagne)	GB
Libéria	LR	Rwanda	RW
Libye	LY	Sahara Occidental	EH
Liechtenstein	LI	Sainte-Hélène	SH
Lituanie	LT	Saint-Kitts-et-Nevis	KN
Luxembourg	LU	Sainte-Lucie	LC
Macao	MO	Saint-Marin	SM
Macédoine	MK	Saint-Marin (Partie Néerlandaise)	SX
Madagascar	MG	Saint-Siège(Vatican)	VA
Malaisie	MY	Saint-Vincent-et-les Grenadines(a,b)	VC
Malawi	MW	Salomon, Îles	SB
Maldives	MV	Samoa	WS
Mali*	ML	SaoTomé-et-Principe	ST
Malte	MT	Sénégal*	SN
Mariannes du Nord, Îles	MP	Serbie	RS
Maroc	MA	Seychelles	SC
Maurice	MU	Sierra Leone	SL
Mauritanie*	MR	Singapour	SG
Mexique	MX	Slovaquie	SK
Moldova	MD	Slovénie	SI
Monaco	MC	Somalie	SO

Mongolie	MN	Soudan	SD
Monténégro	ME	SriLanka	LK
Montserrat	MS	Suède	SE
Mozambique	MZ	Suisse	CH
Myanmar(Birmanie)	MM	Suriname	SR
Namibie	NA	Swaziland	SZ
Nauru	NR	Syrie	SY
Népal	NP	Tadjikistan	TJ
Nicaragua	NI	Taiwan,Province de Chine	TW
Niger*	NE	Tanzanie (Rép.-Unie)	TZ
Nigéria	NG	Tchad*	TD
Thaïlande	TH	Tchèque,République	CZ
Timor Oriental	TP	Ukraine	UA
Togo*	TG	Uruguay	UY
Tonga	TO	Vanuata	VU
Trinité-et-Tobago	TT	Venezuela	VE
Tunisie	TN	VietNam	VN
Turkménistan	TM	Yémen	YE
Turks et Caïques,Îles	TC	Yougoslavie	YU
Turquie	TR	Zambie	ZM
Tuvalu	TV	Zimbabwe	ZW

ORGANISATIONS INTERNATIONALES DELIVRANT OU ENREGISTRANT DES TITRES DE PROPRIETE INDUSTRIELLE

Bureau Benelux des marques et des dessins et modèles industriels	BX
Office Communautaire des variétés végétales (Communauté Européenne (OCVV))	QZ
Office de l'harmonisation dans le marché intérieur (Marque, dessins et modèles)	EM
Office des Brevets du conseil de Coopération des Etats du Golf (CCG)	GC
Office Européen des Brevets (OEB)	EP
Organisation Mondiale de la Propriété Intellectuelle (OMPI)	WO
Bureau International de l'OMPI	IB
Organisation Africaine de la Propriété Intellectuelle (OAPI)	OA
Organisation Eurasienne des Brevets (OEAB)	EA
Organisation Régionale Africaine de la Propriété Industrielle (ARIPO)	AP

*Etats membres de l'OAPI

**CODES UTILISES EN MATIERE D'INSCRIPTIONS DANS
LE REGISTRE SPECIAL DES MARQUES DE PRODUITS OU DE SERVICES
ET DES DESSINS OU MODELES INDUSTRIELS**

- (1) Numéro d'enregistrement.
- (2) Numéro de dépôt ou de procès-verbal.
- (3) Nature de l'inscription.
- (4) Nom du bénéficiaire de l'inscription, nouvelle adresse ou dénomination, etc.
- (5) Le(s) numéro(s) de l'inscription.
- (6) Date(s) d'inscription.

**CODES UTILISES EN MATIERE DE DOCUMENTATION
DE DESSINS ET MODELES INDUSTRIELS**

- (11) Numéro d'enregistrement.
- (21) Numéro de dépôt ou de P.V.
- (22) Date de dépôt.
- (30) Priorité(s) : Date(s), pays (code de la norme ST. 3 de l'OMPI) et numéro(s).
- (51) Classification internationale des dessins et modèles industriels
(Classification de LOCARNO).
- (54) Désignation précise de(s) produit(s) au(x) quel(s) le(s) dessin(s) ou modèle(s) industriel(s)
est (sont) destiné(s) à être incorporés : Titre du (des) dessin(s) ou modèle(s) industriel(s)
- (55) Reproduction du dessin ou modèle industriel (par exemple, dessin, photographie).
- (71) Nom(s) et adresse(s) du (des) déposant(s).
- (72) Nom(s) et adresse(s) de(s) auteur(s) de(s) dessin(s) ou modèle(s) industriel(s).
- (74) Nom et adresse du mandataire.

**CODES UTILISES EN MATIERE DE DESSINS
ET MODELES INDUSTRIELS RENOUVELES**

- (1) Numéro d'enregistrement.
- (2) Numéro et date de dépôt.
- (3) Classe(s) internationale(s).
- (4) Titre du (des) dessin(s) ou modèle(s) industriel(s).
- (5) Nom(s) et adresse(s) du (des) déposant(s).
- (6) Nom(s) et adresse(s) de(s) auteur(s).
- (7) Numéro du renouvellement.
- (8) Nom et adresse du Mandataire.

**CLASSIFICATION INTERNATIONALE POUR LES DESSINS ET MODELES INDUSTRIELS ETABLIE EN VERTU
DE L'ARRANGEMENT DE LOCARNO DU 8 OCTOBRE 1968 (9^{ème} ÉDITION)**

- Classe 1 Produits alimentaires :** Boulangerie, biscuits, pâtisserie, pâtes et autres produits à base de céréales, chocolats, confiserie, glaces; fruits et légumes; fromages, beurre et succédanés du beurre, autres produits laitiers; produits de boucherie, de charcuterie et de poissonnerie; aliments pour animaux.
- Classe 2 Articles d'habillement et mercerie :** Sous- vêtements, lingerie, corsets, soutiens-gorge, vêtements de nuit; vêtements; articles de chapellerie; chaussures, bas et chaussettes; cravates, écharpes, foulards et mou- choirs; ganterie; mercerie et accessoires d'habillement.
- Classe 3 Articles de voyages, étuis, parasols et objets personnels, non compris dans d'autres classes :** Malles, valises, serviettes, sacs à main, porte-clés, étuis adaptés à leur contenu, portefeuilles; parapluies, parasols, ombrelles et cannes; éventails.
- Classe 4 Brosserie :** Brosses, pinceaux et balais de nettoyage; brosses et pinceaux de toilette, brosses pour vêtements et brosses à chaussures; brosses pour machines; brosses et pinceaux à peindre, pinceaux pour cuisiner.
- Classe 5 Articles textiles non confectionnés, feuilles de matière artificielle ou naturelle :** Filés, dentelles; broderies; rubans, galons et autres articles de passemen- terie; tissus et étoffes; feuilles de matière artificielle ou naturelle.
- Classe 6 Ameublement :** Lits et sièges; tables et meubles; meubles de rangement; meubles combinés; autres pièces de mobilier et parties de meubles; miroirs et cadres; cintres; matelas et coussins; rideaux et stores intérieurs; tapis de sol, paillassons et carpettes; tapisseries; couvertures, linge de maison et de table.
- Classe 7 Articles de ménage non compris dans d'autres classes :** Vaisselle et verrerie; appareils, ustensiles et récipients pour la cuisson; couteaux de table, fourchettes, cuillers; appareils et ustensiles, mus manuellement, pour préparer la nourriture ou les boissons; fers à repasser, ustensiles pour laver, nettoyer ou sécher; autres ustensiles de table; autres récipients de ménage; accessoires de cheminée d'appartement.
- Classe 8 Outils et quincaillerie :** Outils et instruments servant à forer, à fraiser ou à creuser; marteaux, outils et instruments analogues; outils et instruments tranchants; tournevis, outils et instruments analogues; autres outils et instruments; poignées, boutons et gonds; dispositifs de verrouillage ou de fermeture. Moyens de fixation, de soutien ou de montage, non compris dans d'autres classes; ferrures et dispositifs analogues; râteliers à bicyclettes.
- Classe 9 Emballages et récipients pour le transport ou la manutention des marchandises :** Bouteilles, flacons, pots, bonbonnes, récipients munis d'un système à pression; bidons et fûts; boîtes, caisses, conteneurs, boîtes à conserves; cageots et paniers; sacs, sachets, tubes et capsules; cordes et matériaux de cerclage; moyens de fermeture et accessoires; palettes et plates- formes de manutention; poubelles et conteneurs pour ordures et leurs supports.
- Classe 10 Horlogerie et autres instruments de mesure, instruments de contrôle ou de signalisation :** Horloges, pendules et réveils; montres et montres-bracelets; autres instruments de mesure du temps; autres instruments, appareils et dispositifs de mesure; instruments, appareils et dispositifs de contrôle, de sécurité ou d'essai; appareils et dispositifs de signalisation; boîtes, boîtiers, cadrans, aiguilles et toutes les autres pièces et accessoires d'instruments de mesure, de contrôle ou de signalisation.
- Classe 11 Objets d'ornement :** Bijouterie et joaillerie; bibelots, ornements de table, de dessus de cheminée ou de mur, vases et pots à fleurs; médailles et insignes; fleurs, plantes et fruits artificiels; drapeaux, articles de décoration de fête.
- Classe 12 Moyens de transport ou de levage :** Véhicules à traction animale; chariots à main, brouettes; locomotives et matériel roulant pour les chemins de fer et tous autres véhicules sur rail; téléphériques, télésièges et remonte-pentes; élévateurs, appareils de levage ou de manutention; navires et bateaux; avions et autres véhicules aériens ou spatiaux; automobiles, autobus et camions; tracteurs; remorques et véhicules routiers; cycles et motocycles; voitures d'enfant, fauteuils roulants pour infirmes, brancards; véhicules à usages spéciaux; autres véhicules; pneus, bandages et chaînes antidérapantes pour véhicules; parties, équipements et accessoires de véhicules, non compris dans d'autres classes ou sous- classes.
- Classe 13 Appareils de production, de distribution ou de transformation de l'énergie électrique :** Générateurs et moteurs; transformateurs, redresseurs, piles et accumulateurs; matériel de distribution ou de commande d'énergie électrique.
- Classe 14 Appareils d'enregistrement, de télécom- munication ou de traitement de l'information :** Appareils d'enregistrement ou de reproduction de sons ou d'images; appareils pour le traitement de l'information ainsi que les appareils et dispositifs périphériques; appareils de télécommunication et de télécommande sans fil, amplificateurs-radios.
- Classe 15 Machines non comprises dans d'autres classes :** Moteurs; pompes et compresseurs; machines agricoles; machines pour bâtir; machines pour laver, nettoyer ou sécher; machines textiles, machines à coudre, à tricoter ou à broder, y compris leurs parties intégrantes; machines et appareils de réfrigération; machines-outils, machines à abraser, machines de fonderie.
- Classe 16 Articles de photographie, décinématographie ou d'optique :** Appareils pour photographier ou filmer; appareils de projection et visionneuses; appareils pour photocopier ou agrandir; appareils et ustensiles pour le développement; accessoires; articles d'optique.
- Classe 17 Instruments de musique :** Instruments à clavier; instruments à vent; instruments à cordes; instruments à percussion;

instruments mécaniques.

- Classe 18 Imprimerie et machines de bureau** : Machines à écrire ou à calculer; machines pour l'impression; caractères et signes typographiques; machines à relier, agrafeuses d'imprimerie, massicots.
- Classe 19 Papeterie, articles de bureau, matériel pour artistes ou d'enseignement** : Papier à écrire, cartes de correspondance et faire-part; articles de bureau; calendriers; livres, cahiers et objets d'aspect extérieur semblable; matériel et instruments pour écrire à la main, pour dessiner, pour peindre, pour sculpter, pour graver ou pour d'autres techniques artistiques; matériel d'enseignement; autres imprimés.
- Classe 20 Equipement de vente ou de publicité, signes indicateurs** : Distributeurs automatiques; matériel d'exposition ou de vente; signes indicateurs, dispositifs publicitaires.
- Classe 21 Jeux, jouets, tentes et articles de sport** : Jeux et jouets; appareils et articles de gymnastique ou de sport; autres articles d'amusement et de divertissement; tentes et accessoires.
- Classe 22 Armes, articles pyrotechniques, articles pour la chasse, la pêche et la destruction d'animaux nuisibles** : Armes à projectiles; autres armes; munitions, fusées et articles pyrotechniques; cibles et accessoires; articles pour la chasse ou la pêche; pièges, articles pour la destruction d'animaux nuisibles.
- Classe 23 Installations pour la distribution de fluides, installations sanitaires, de chauffage, de ventilation ou de conditionnement d'air, combustibles solides** : Installations pour la distribution de fluides; installations sanitaires; équipements pour le chauffage; ventilation et conditionnement d'air; combustibles solides.
- Classe 24 Médecine et laboratoires** : Appareils et installations pour médecins, hôpitaux ou laboratoires, instruments médicaux, instruments et ustensiles de laboratoire; prothèses; articles de pansement, de bandage et de soins médicaux.
- Classe 25 Constructions et éléments de construction** : Matériaux de construction; parties de construction préfabriquées ou préassemblées; maisons, garages et autres constructions; escaliers, échelles et échafaudages.
- Classe 26 Appareils d'éclairage** : Bougeoirs et chandeliers; torches, lampes et lanternes portatives; appareils d'éclairage public; sources lumineuses, électriques ou non; lampes, lampadaires, lustres, appliques murales ou de plafond, abat-jour, réflecteurs, lampes pour projecteurs de photographie ou de cinématographie; dispositifs lumineux de véhicules.
- Classe 27 Tabacs et articles pour fumeurs** : Tabacs, cigares et cigarettes; pipes, fume-cigares et fume-cigarettes; cendriers; allumettes; briquets; étuis à cigares, étuis à cigarettes, tabatières et pots à tabac.
- Classe 28 Produits pharmaceutiques ou cosmétiques, articles et équipements de toilette** : Produits pharmaceutiques; produits cosmétiques; articles de toilette et équipements pour soins de beauté; cheveux, barbes et moustaches postiches.
- Classe 29 Dispositifs et équipements contre le feu, pour la prévention d'accidents ou le sauvetage** : Dispositifs et équipements contre le feu; dispositifs et équipements pour la prévention d'accidents ou le sauvetage, non compris dans d'autres classes.
- Classe 30 Articles pour les soins et l'entretien des animaux** : Vêtements pour animaux; enclos, cages, niches et abris analogues; nourrisseurs et abreuvoirs; sellerie; fouets et aiguillons; litières et nids; perchoirs et autres accessoires de cages; marqueurs, marques et entraves; poteaux d'attache.
- Classe 31 Machines et appareils pour préparer la nourriture ou les boissons, non compris dans d'autres classes** : Machines et appareils pour préparer la nourriture et les boissons, non compris dans d'autres classes.
- Classe 32 Symboles graphiques et logos, motifs décoratifs pour surfaces, ornementation** : Symboles graphiques et logos, motifs décoratifs pour surfaces, ornementation.

CLARIFICATION DU REGLEMENT RELATIF A L'EXTENSION DES DROITS SUITE A UNE NOUVELLE ADHESION A L'ACCORD DE BANGUI

RESOLUTIONN°47/32

LE CONSEIL D'ADMINISTRATION DE L'ORGANISATION AFRICAINE DE LAPROPRIETE INTELLECTUELLE

- Vu L'accord portant révision de l'accord de Bangui du 02 Mars 1977 instituant une Organisation Africaine de la Propriété Intellectuelle et ses annexes ;
- Vu Les dispositions des articles 18 et 19 dudit Accord relatives Aux attributions et pouvoirs du Conseil d'Administration ;

ADOPTE la clarification du règlement du 04 décembre 1988 relatif à l'extension des droits suite à une nouvelle adhésion à l'Accord de Bangui ci-après :

Article 1er :

Le Règlement du 04 décembre 1988 relatif à l'extension des droits suite à une nouvelle adhésion à l'Accord de Bangui est réaménagé ainsi qu'il suit :

« Article 5 (nouveau) :

Les titulaires des titres en vigueur à l'Organisation avant la production des effets de l'adhésion d'un Etat à l'accord de Bangui ou ceux dont la demande a été déposée avant cette date et qui

voudront étendre la protection dans ces Etats doivent formuler une demande d'extension à cet effet auprès de l'Organisation suivant les modalités fixées aux articles 6 à 18 ci-dessous.

Le renouvellement de la protection des titres qui n'ont pas fait l'objet d'extension avant l'échéance dudit renouvellement entraîne une extension automatique des effets de la protection à l'ensemble du territoire OAPI».

Le reste sans changement.

Article 2 :

La présente clarification, qui entre en vigueur à compter du 1^{er} janvier 2008, s'applique aussi aux demandes d'extension en instance et sera publiée au Bulletin Officiel de l'Organisation.

Fait à Bangui le 17 décembre 2007

STRUCTURES NATIONALES DE LIAISON (SNL)

BENIN-Cotonou

Agence Nationale de la Propriété Industrielle (ANAPI)

Tel.: (229) 21 31 02 40
Fax.: (229) 21 30 30 24
01 B.P. 363 Cotonou 01

BURKINA FASO-Ouagadougou

Direction Nationale de la Propriété Industrielle (DNPI)

(Ministère de l'Industrie, du Commerce et de l'Artisanat)
Tél. : (226) 50 30 09 41
Fax : (226) 50 33 05 63
01 B.P. 258 Ouagadougou

CAMEROUN-Yaoundé

Direction du Développement Technologique et de la Propriété Industrielle

(Ministère des Mines, de l'Industrie et du Développement Technologique)
Tel. : (237) 22 20 37 78
Fax.: (237) 22 20 37 38
B.P. 1652 Yaoundé

CENTRAFRIQUE-Bangui

Direction de la Propriété Industrielle (Ministère du Commerce et de l'Industrie)

Tél. : (236) 21 61 17 44
Fax : (236) 21 61 76 53
Avenue B. BOGANDA
B.P. 1988 Bangui

COMORES-Moroni

Office comorien de la propriété intellectuelle

Tél. : 269 333 53 60
Fax : 269 775 00 03
B.P. 41 Moroni

CONGO-Brazzaville

Antenne Nationale de la Propriété Industrielle (ANPI)

(Ministère du Développement Industriel et de la Promotion du Secteur Privé)
Tél. : (242) 581 56 57
Fax : (242) 581 54 80
B.P. : 72 Brazzaville

COTE D'IVOIRE-Abidjan

Office Ivoirien de la Propriété Industrielle (OIP)

Tel. : (225) 20 33 53 43/44
Fax: (225) 20 33 53 45
01 B.P. 2337 Abidjan

GABON-Libreville

Centre de la Propriété Industrielle du Gabon (CEPIG)

(Ministère du Commerce et du Développement Industriel, Chargé du NEPAD)
Tel. : (241) 01 74 59 24
Fax. : (241) 01 76 30 55
B.P. : 1025 Libreville

GUINEE-Conakry

Service National de la Propriété Industrielle

(Ministère de l'Industrie, des Petites et Moyennes Entreprises)
Tel. : (224) 30 41 17 20/60 58 53 61
Fax: (224) 41 25 42/41 39 90
B.P. 468 Conakry

GUINEE BISSAU-Bissau

Direction Générale de la Propriété Industrielle

(Ministère du Commerce, de l'Industrie et de la Promotion des Produits locaux)
Tél : (245) 322 22 75
Fax : (245) 322 37 65
B.P. : 269 Bissau

GUINEE EQUATORIALE-Malabo

Direction de la Propriété Intellectuelle

(Conseil de la Recherche Scientifique et Technique - CICTE)
Tel. : (240) 222 09 24 84
Fax : (240) 333 09 33 13
B.P. : 528 Malabo

MALI-Bamako

Centre Malien de la Propriété Industrielle (CEMAPI)

Tel. : (223) 20 29 90 90
Fax: (223) 20 29 90 91
B.P. : 278 Bamako

MAURITANIE-Nouakchott

Service de la Technologie et de la Propriété Industrielle

(Ministère du Commerce, de l'Industrie, de l'Artisanat et du Tourisme)
Tel. : (222) 525 72 66
Fax: (222) 525 69 37
B.P. : 387 Nouakchott

NIGER-Niamey

Direction de l'Innovation et de la Propriété Intellectuelle

(Ministère des Mines et du Développement Industriel)
Tél. : (227) 20 73 58 25
Fax : (227) 20 73 21 50
B.P. : 480 Niamey

SENEGAL-Dakar

Agence Sénégalaise pour la Propriété Industrielle et l'Innovation Technologique (ASPIT)

Tel. : (221) 33 869 47 70
Fax: (221) 33 827 30 14
B.P. : 4037 Dakar

TCHAD-N'djamena

Division de la Propriété Industrielle et de la Technologie

(Ministère du Commerce et de l'Industrie)

Tel. : (235) 22 52 08 67
Fax: (235) 22 52 21 79
B.P. : 424 N'Djamena

TOGO-Lomé

Institut National de la Propriété Industrielle et de la Technologie (INPIT)

Tel. : (228) 222 10 08
Fax : (228) 222 44 70
B.P. : 2339 Lomé



B.P. 887 Yaoundé-Cameroun Tél : (237) 22 20 57 00
E-mail : oapi@oapi.int Fax : (237) 22 20 57 27

www.oapi.int

DEUXIEME PARTIE
DESSINS ET MODELES INDUSTRIELS
DU N° 04326 AU 04370

(11) **04326**

(21) 4201400277

(22) 03.06.2014

(51) 5

(54) Articles textiles non confectionnés : tissus imprimés.

(55)



1.1

(71) M. Issoufou BOUBE, 295 rue des Dattiers, B.P. 10025, NIAMEY (NE).

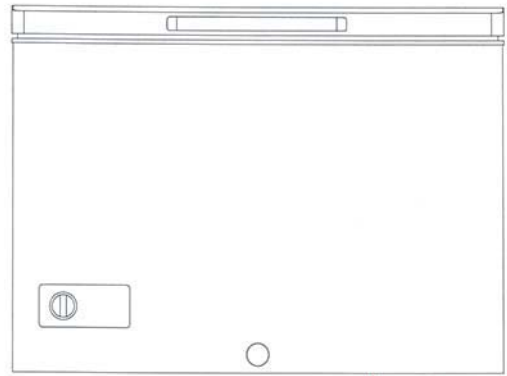

1.2

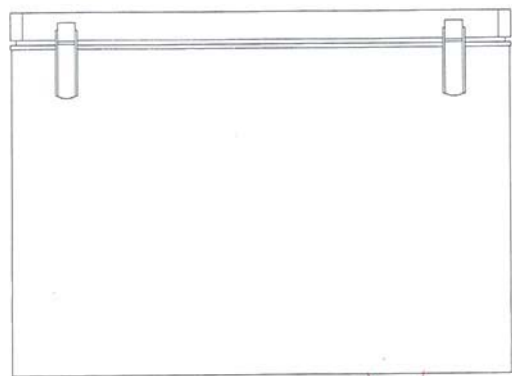

1.3

(11) **04328**

(21) 4201300277

(22) 19.08.2013

(30) KR n° 30-2013-0008805 du 20/02/2013

(51) 15

(54) Refrigeration machinery and apparatus.

(55)

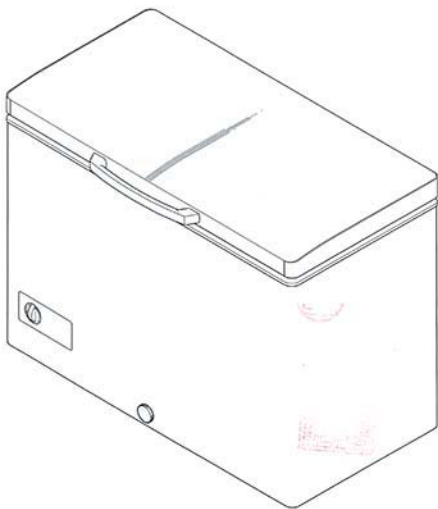

1.1

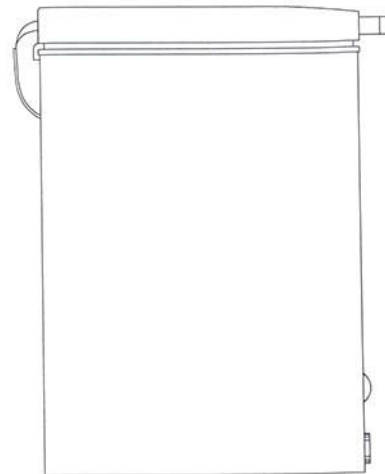

1.4

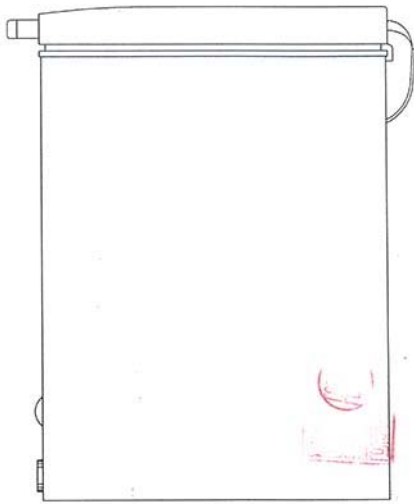

1.5

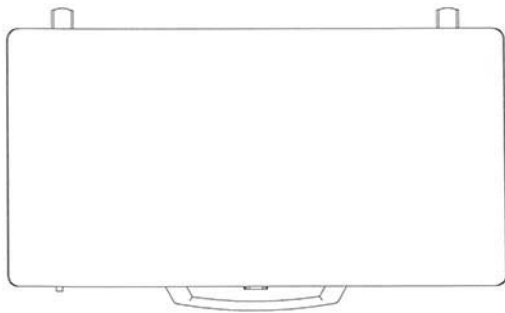

1.6

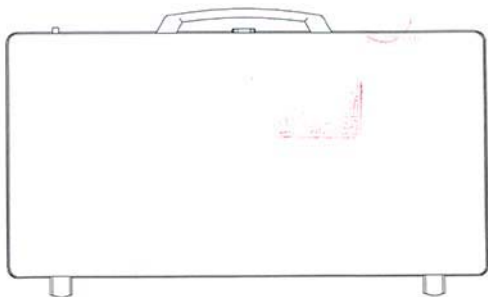

1.7

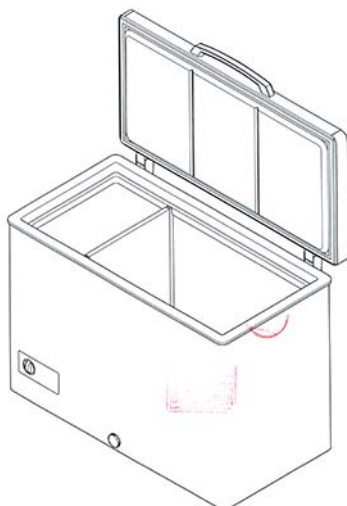

1.8

(71) Samsung Electronics Co., Ltd, 129, Samsung-ro, Yeongtong-gu, SUWON-SI, Gyeonggi-do 443-742 (KR)

(72) LEE Seon-Ju, 2503, Hanhwa Jin Nexvill 706-20, Youksam-2 dong, Gangnam-gu, SEOUL (KR); KIM AeRyun, 203, 939-12, Daechi-4 dong, Gangnam-gu, SEOUL (KR); LEE Yukyung, 33-8, 744-8, Chang-4 dong 743-745, Dobong-gu, SEOUL (KR)

(74) Cabinet ÉKÉMÉ LYSAGHT SARL, B.P. 6370, YAOUNDE (CM).

(11) **04329**

(21) 4201300278

(22) 19.08.2013

(51) 15

(54) Machines et appareils de réfrigération.

(55)

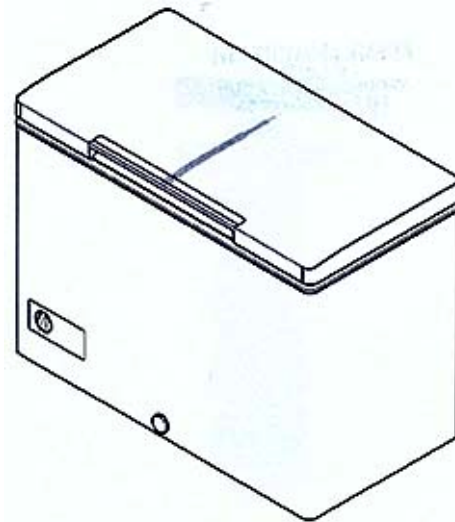

1.1

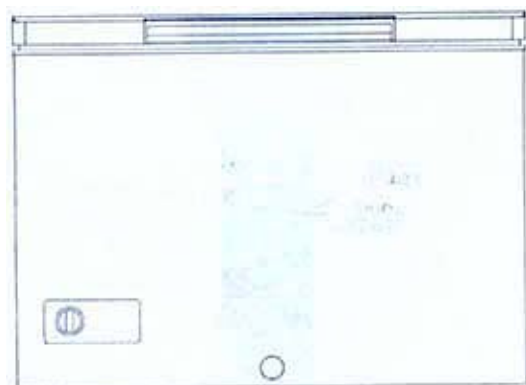

1.2

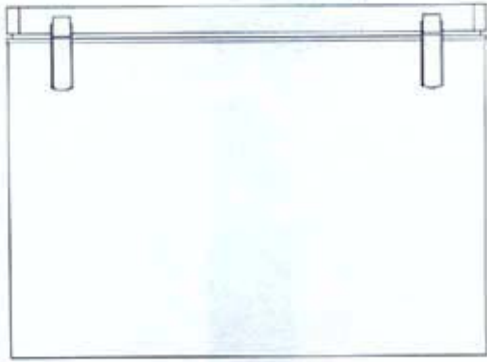

1.3



1.6

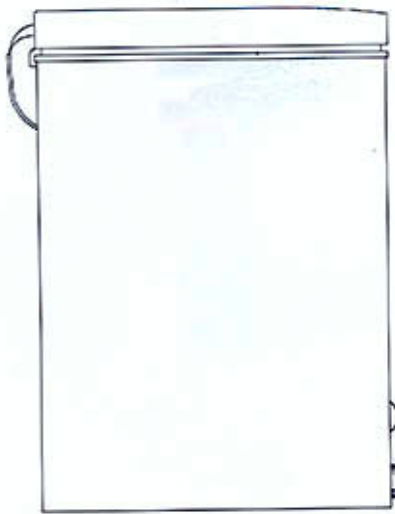

1.4

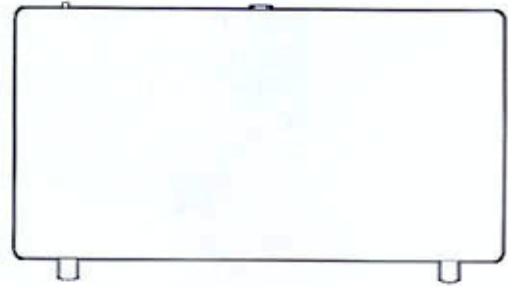

1.7

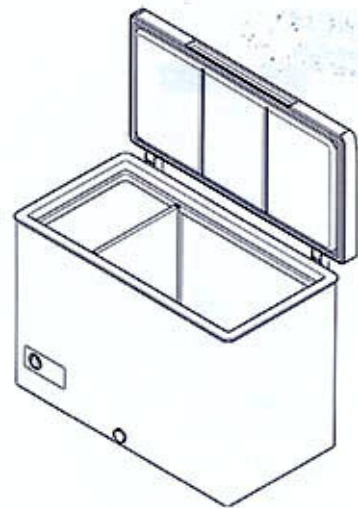

1.8

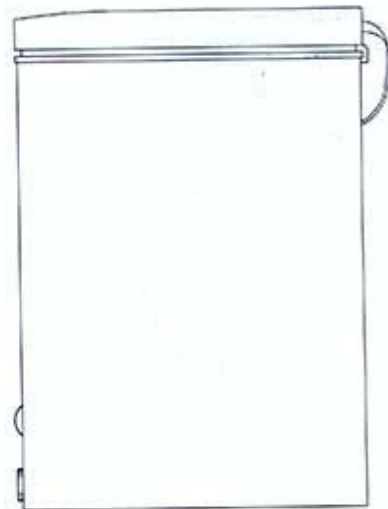

1.5

(71) Samsung Electronics Co., Ltd, 129, Samsung-ro, Yeongtong-gu, SUWON-SI, Gyeonggi-do 443-742 (KR)

(72) LEE Seon-Ju, 2503, Hanhwa Jin Nexvill 706-20, Youksam-2 dong, Gangnam-gu, SEOUL (KR); KIM AeRyun, 203, 939-12, Daechi-4 dong, Gangnam-gu, SEOUL (KR); LEE Yukyung, 33-8, 744-8, Chang-4 dong 743-745, Dobong-gu, SEOUL (KR)

(74) Cabinet ÉKÉMÉ LYSAGHT SARL, B.P. 6370, YAOUNDE (CM).

(11) **04330**

(21) 4201300307

(22) 16.08.2013

(51) 6

(54) Meubles en plastique.

(55)



1.1



3.1



4.1



2.1



5.1



6.1



9.1



7.1



10.1



8.1

(71) TRANSFORMATION INDUSTRIELLE DU PLASTIQUE (T.I.P), 01 B.P. 7549, ABIDJAN 01 (CI).

(11) **04331**

(21) 4201300250

(22) 10.01.2013

(51) 7

(54) Articles de ménage.

(55)



1.1



1.2



2.1



2.2



3.1



3.2

(71) TRANSFORMATION INDUSTRIELLE DU PLASTIQUE (T.I.P), 01 B.P. 7549, ABIDJAN 01 (CI).

(11) **04332**

(21) 4201300191

(22) 28.06.2013

(51) 32

(54) Symboles graphiques et logos.

(55)



1.1

(71) Observatoire de la Presse Etrangère et Nationale (OPEN), B.P. 164, YAOUNDE (CM)

(74) Cabinet EKANI-CONSEILS, B.P. 5852, YAOUNDE (CM).

(11) **04333**

(21) 4201400256

(22) 30.06.2014

(51) 7

(54) Autres récipients de ménage : récipients pour entreposage de bouteille de gaz.

(55)

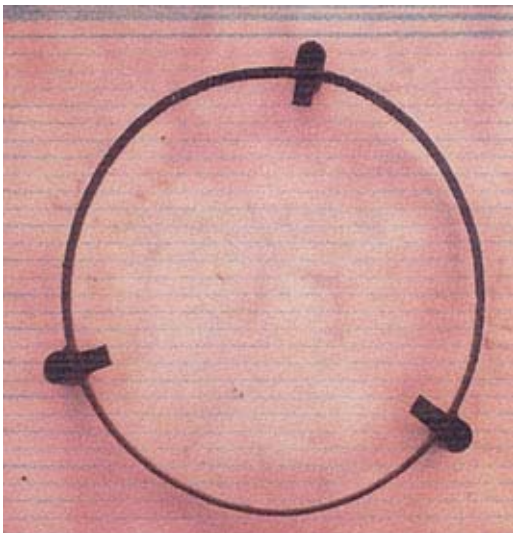

1.1

(71) EMERUWA EDJIKEME, 22 B.P. 1045, ABIDJAN 22 (CI).

(11) **04334**

(21) 4201400257

(22) 30.06.2014

(51) 25

(54) Eléments et matériaux de constructions : closoir de faitage.

(55)

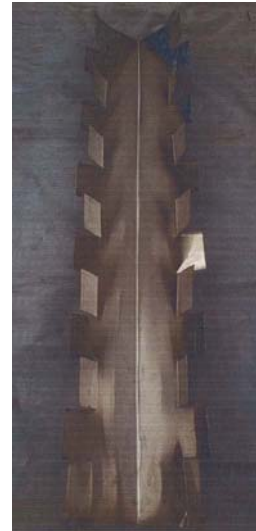

1.1

(71) EMERUWA EDJIKEME, 22 B.P. 1045, ABIDJAN 22 (CI).

(11) **04335**

(21) 4201400260

(22) 16.07.2014

(51) 9

(54) Bouteille.

(55)



1.1



1.2

(71) BAMA INDUSTRIE (l'Unité de fabrication d'article ménagers en plastique préformes et bouchons), Moribabougou, Rue 309 Porte 903, KATI (ML).



1.2

(71) Sory KANTAKO, Rue Brière de Lysle, Grand marché, BAMAKO (ML).

(11) **04336**

(21) 4201400261

(22) 23.07.2014

(51) 2

(54) Chaussures.

(55)



1.1

(11) **04337**

(21) 4201400263

(22) 31.07.2014

(30) IN n° 259936 du 31/01/2014

(51) 12

(54) Means of transport or hoisting including: vehicles drawn by animals, handcarts, wheelbarrows; locomotives and rolling stock for railways and all other rail vehicles, trolley carriers, chair lifts and ski lifts, elevators and hoists for loading or conveying, hips and boats, aircraft and space vehicles, motor cars, buses and lorries, tractors, road vehicle trailers, cycles and motorcycles, perambulators, invalid chairs, stretchers, special-purpose vehicles, other vehicles, tyres and antiskid chains for vehicles, parts, equipment and accessories for vehicles, not included in other classes or subclasses and all other designs in class 12 not included in other classes

(55)

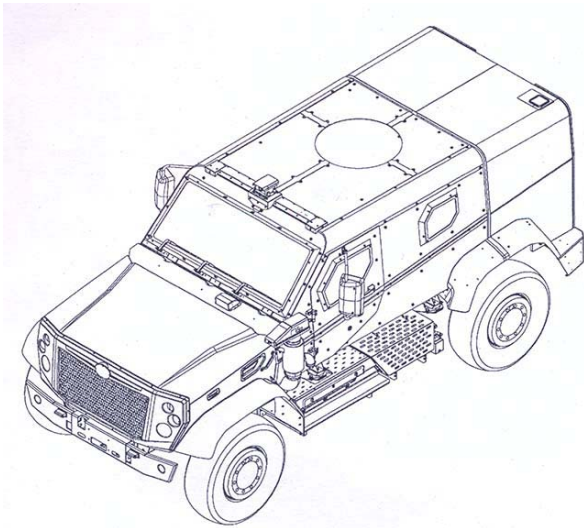

1.1

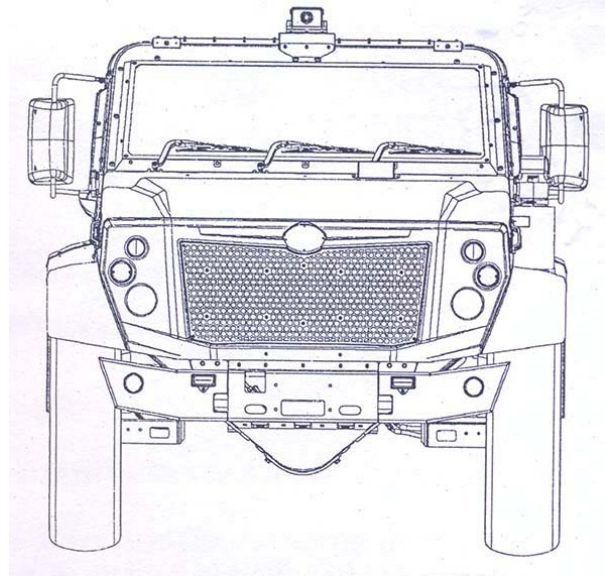

1.5

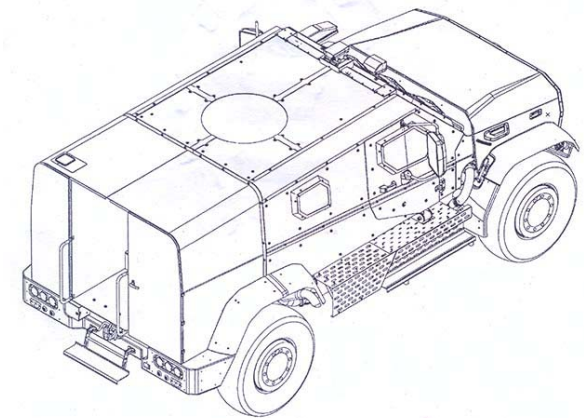

1.2

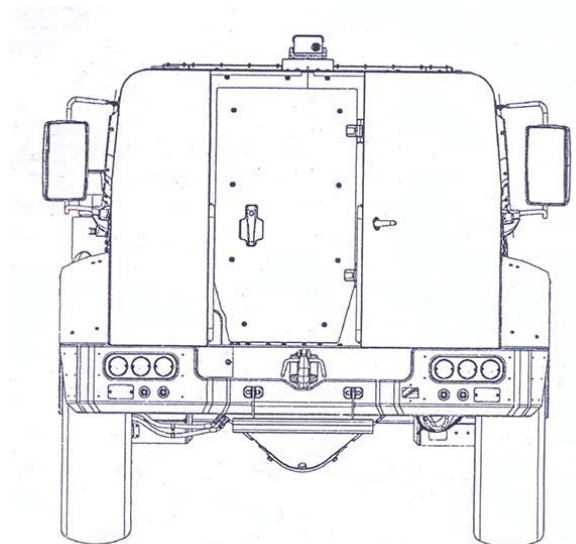

1.6

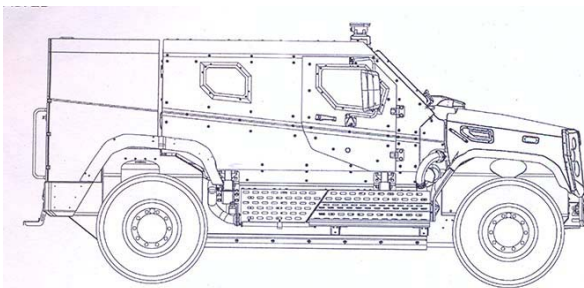

1.3

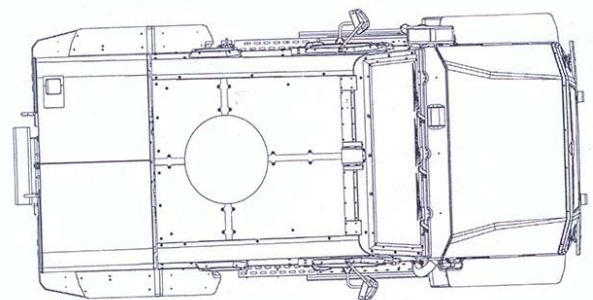

1.7

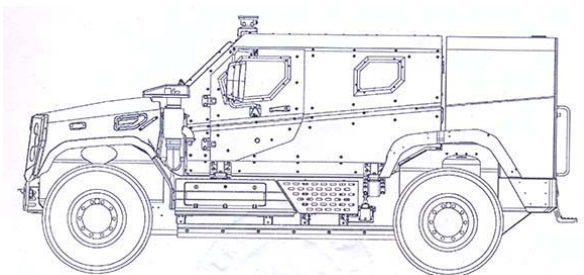

1.4

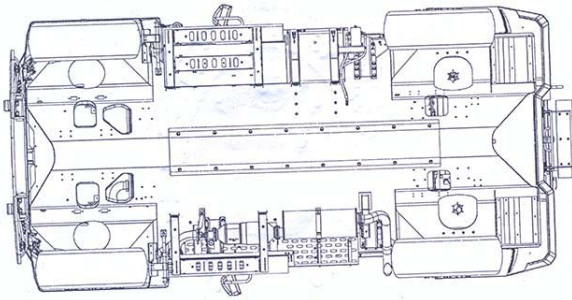

1.8

(71) Tata Motors Limited, Bombay House, 24 Homi Mody Street, Hutatma Chowk, MUMBAI 400 001, Maharashtra, (IN)

(72) Singh, Vijay Veer, A-304, Surobhi Park, New DP Road, Aundh, PUNE-411007 (IN); Kothawade, Amit S, A-8, Ketan Paradise, Sector No-6, Near Spine Road, Moshi Pradhikaran, PCNTDA, PUNE-412105 (IN); Cholkar, Revati Jayant, 110/1/A, L-7, O-302, Balwantpuram Samrajya, Near Vanaz Company. Off Paud, Road, Kothrud, PUNE-411038 (IN)

(74) Cabinet Spoor & Fisher Inc. Ngwafor & Partners, Blvd. du 20 Mai, Immeuble Centre Commercial de l'Hôtel Hilton, 2è Etage, Porte 208A, P.O. Box 8211, YAOUNDE (CM).

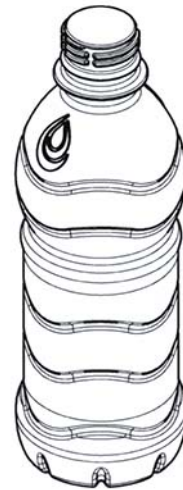

1.2

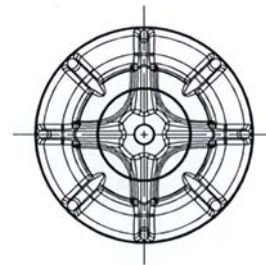

1.3

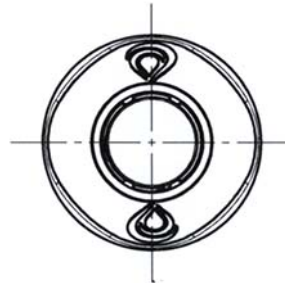

1.4

(11) **04339**

(21) 4201400267

(22) 05.08.2014

(51) 9

(54) Récipients et emballages, bouteilles pour contenir de l'eau minérale et gazeuse et d'autres boissons non alcooliques.

(55)

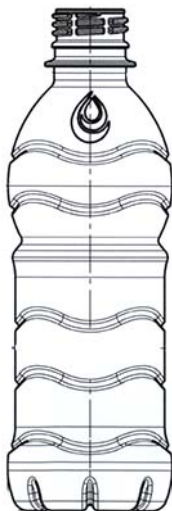

1.1

(71) SOURCE DU PAYS S.A., B.P. 914 , DOUALA (CM)

(72) EL ALI OUSSAMA, B.P. 914 , DOUALA (CM)

(74) Cabinet EKANI-CONSEILS, B.P. 5852, YAOUNDE (CM).

(11) **04340**

(21) 4201400268

(22) 05.08.2014

(51) 9

(54) Récipients et emballages, bouteilles pour contenir de l'eau minérale et gazeuse et d'autres boissons non alcooliques.

(55)

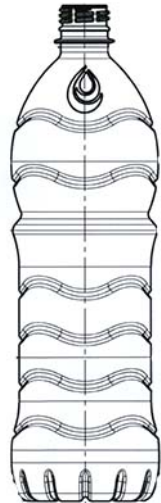

1.1

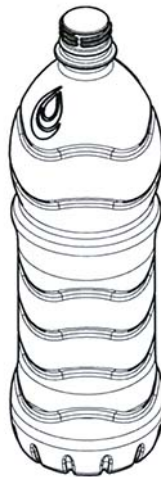

1.2

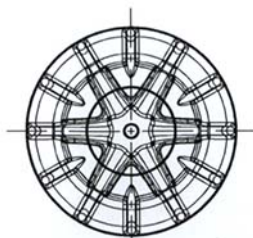

1.3

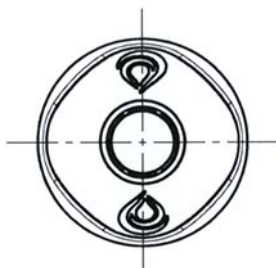

1.4

(71) SOURCE DU PAYS S.A., B.P. 914 , DOUALA (CM)

(72) EL ALI OUSSAMA, B.P. 914 , DOUALA (CM)

(74) Cabinet EKANI-CONSEILS, B.P. 5852, YAOUNDE (CM).

(11) **04341**

(21) 4201400269

(22) 23.06.2014

(51) 19

(54) Papeterie, matériel d'enseignement scolaire.

(55)



1.1



1.2



2.1



3.2



2.2



4.1



3.1



4.2



5.1



6.2



5.2



7.1



6.1



7.2

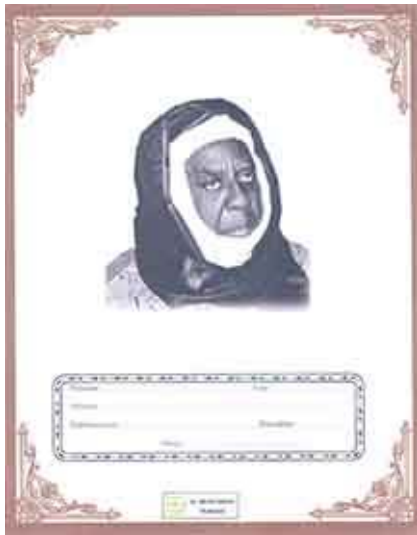

8.1



9.2



8.2



10.1



9.1



10.2



11.1



12.2



11.2



13.1



12.1



13.2



14.1



15.2



14.2



16.1

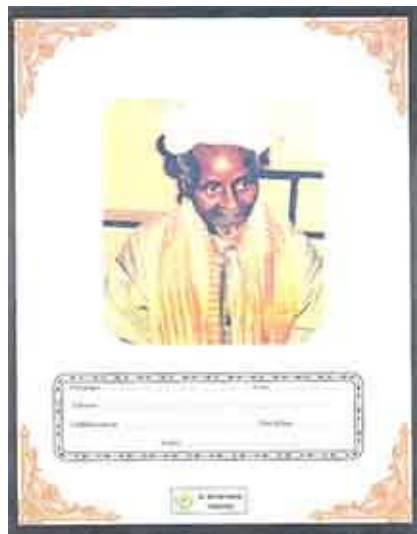

15.1



16.2

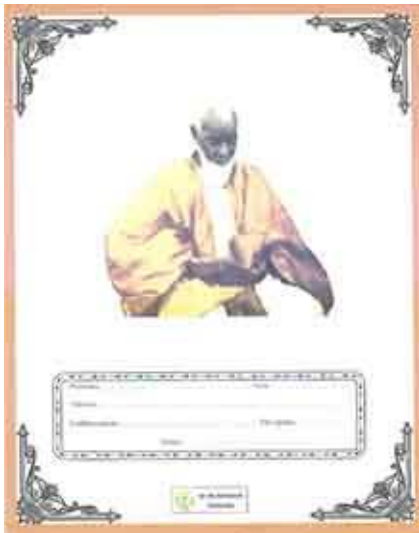

17.1



18.2



17.2



19.1



18.1



19.2



20.1



21.2



20.2



22.1

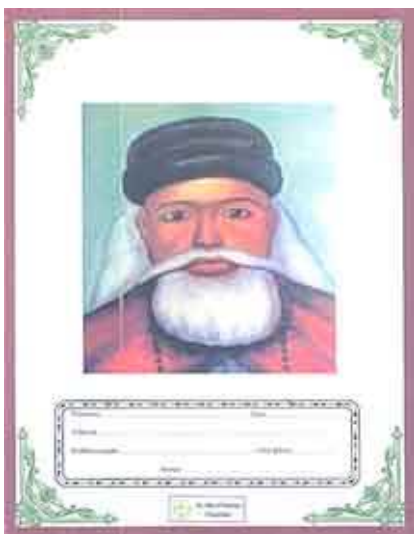

21.1



22.2



23.1



24.2



23.2



25.1



24.1



25.2



26.1



27.2



26.2



28.1



27.1



28.2



29.1



30.2



29.2



31.1

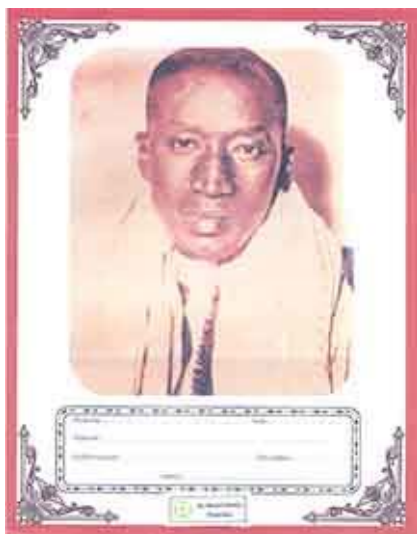

30.1



31.2



32.1



33.2



32.2



34.1



33.1



34.2



35.1



36.2



35.2

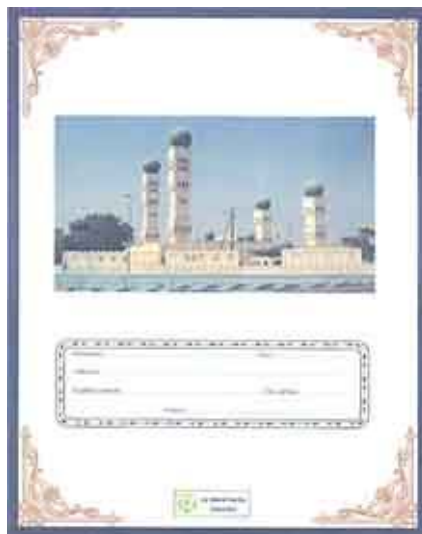

37.1



36.1



37.2

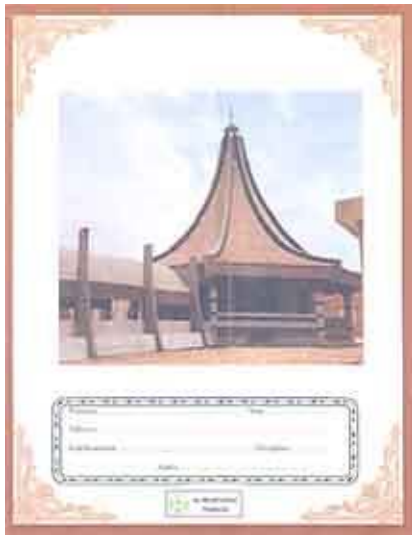

38.1



39.2



38.2



40.1



39.1



40.2

(71) GIE AL Muntakha Trading, Villa n° 508
Cité Mbaba Guisse - Kounoune, B.P. 104,
DAKAR (SN)

(72) SECK Serigne Mbacké, SECK Mohamadou,

SECK Serigne Fallou, MBACKE Ahmadou
Bamba, Villa n° 508 Cité Mbaba Guisse
Kounoune, B.P. 104, DAKAR (SN).

(11) **04342**

(21) 4201400272

(22) 06.08.2014

(51) 20

(54) Matériel d'exposition ou de vente ; signes indicateurs, dispositifs publicitaires.

(55)



1.1



1.2



1.3



1.4

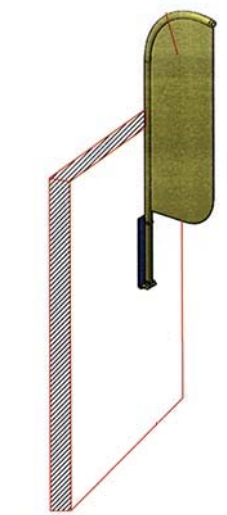

1.5



1.6



1.7



2.1



2.2



2.3

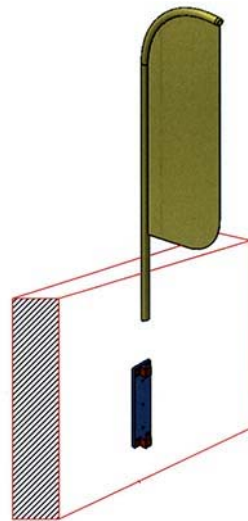

2.4



2.5

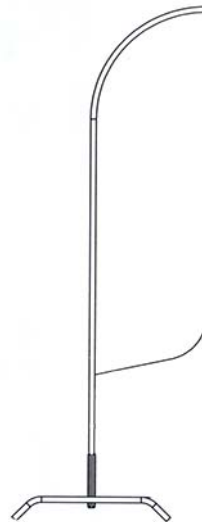

3.1

(71) M. TANKOU François-Xavier, B.P. 5238 ,
DOUALA (CM)

(74) Cabinet EKANI-CONSEILS, B.P. 5852,
YAOUNDE (CM).

(11) **04343**

(21) 4201400273

(22) 06.08.2014

(51) 20

(54) Matériel d'exposition ou de vente ; signes
indicateurs, dispositifs publicitaires.

(55)

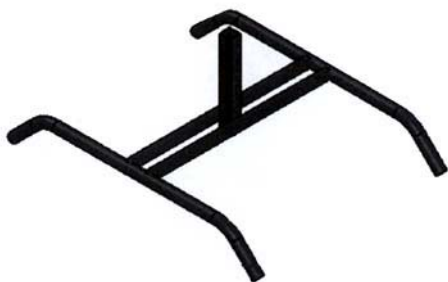
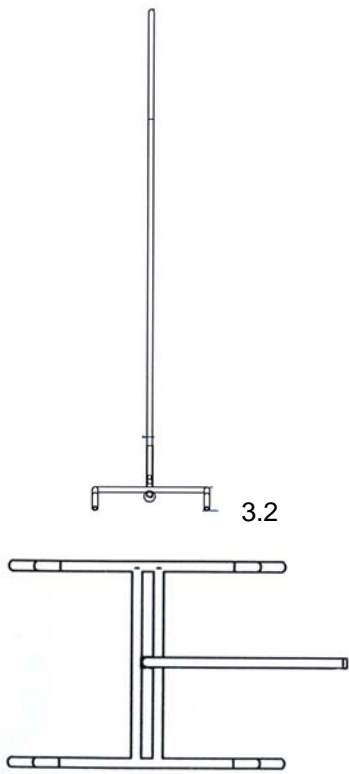



1.3

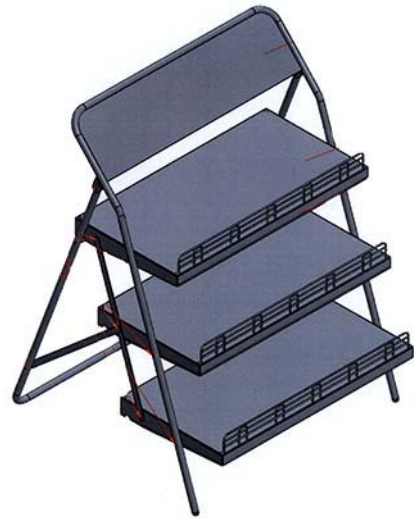

2.1

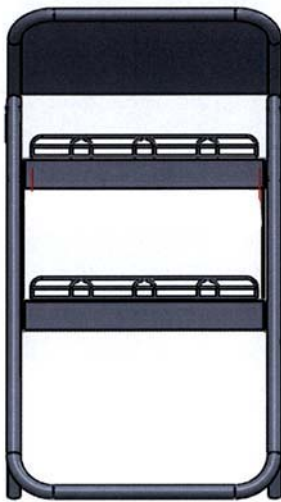

1.4



2.2



1.5



2.3

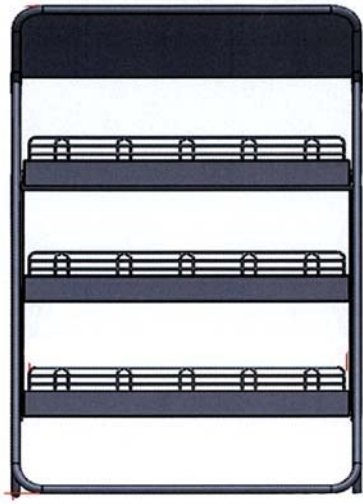

2.4



3.2



2.5



3.3



3.1

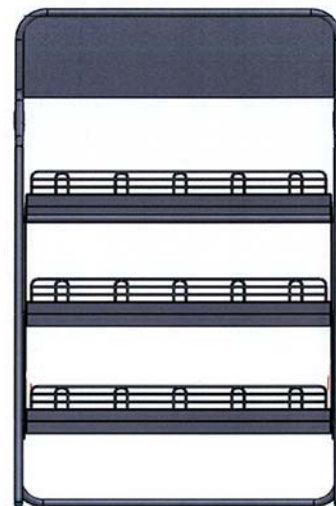

3.4

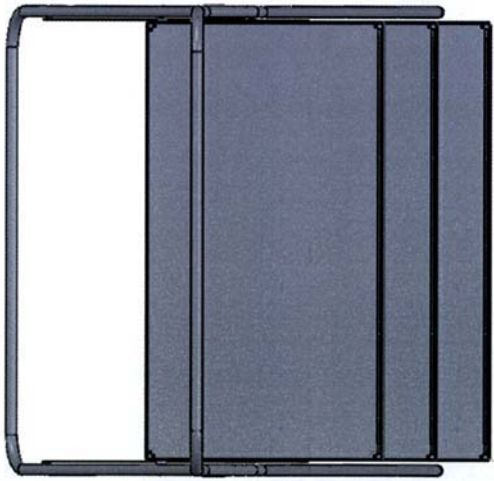

3.5



4.3



4.1

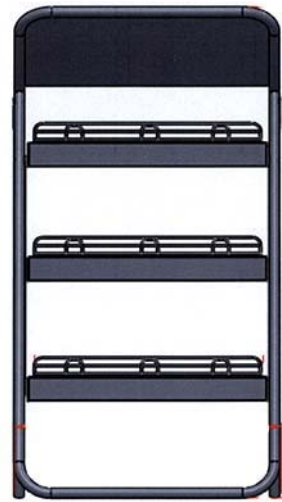

4.4



4.2



4.5



5.1



5.2



5.3



5.4

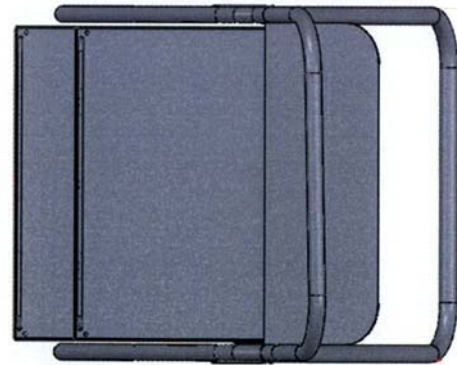

5.5

(71) M. TANKOU François-Xavier, B.P. 5238 ,
DOUALA (CM)

(74) Cabinet EKANI-CONSEILS, B.P. 5852,
YAOUNDE (CM).

(11) **04344**

(21) 4201400274

(22) 22.05.2014

(51) 12

(54) Moyen de transport [véhicule de transport
public urbain].

(55)



1.1

(71) Association de Financement des Professionnels du Transport Urbain (AFTU), Villa n° 9824 Sacré Coeur III, DAKAR (SN)

(72) MBAYE Amar, Villa n° 9824 Sacré Coeur III, DAKAR (SN).

(11) **04345**

(21) 4201400275

(22) 08.08.2014

(51) 7

(54) Articles de ménage non compris dans d'autres classes : vaisselle, appareils, ustensiles et récipients pour la cuisson, ustensiles pour laver, nettoyer ou sécher, autres ustensiles de table.

(55)



3.1



1.1



4.1



2.1



5.1



6.1



9.1



7.1



10.1



8.1



11.1



12.1



15.1



13.1



16.1



14.1



17.1



18.1

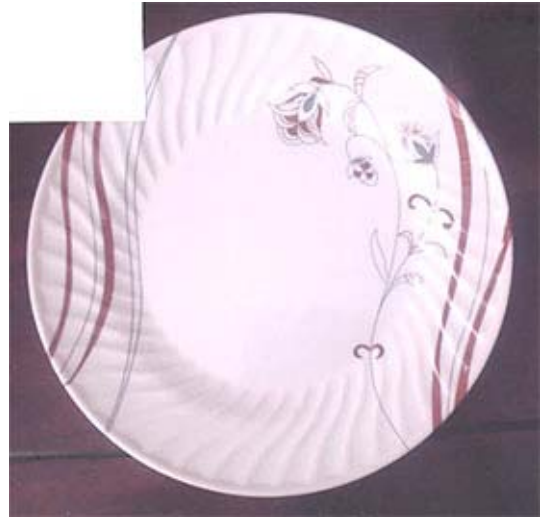

21.1



19.1



22.1



20.1



23.1



24.1



27.1



25.1



28.1



26.1



29.1



30.1



33.1



31.1



34.1



32.1



35.1



36.1



37.1



38.1



39.1



40.1



41.1



42.1



43.1



44.1

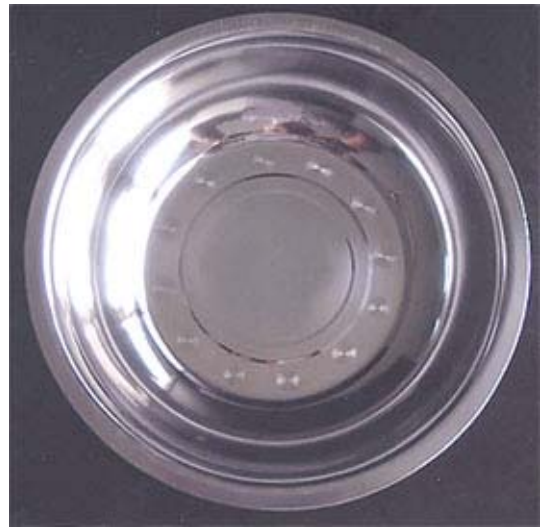

47.1



45.1



45.2



46.1



46.2

(71) SOCIETE T & J SARL, O1
B.P. 4523, COTONOU (BJ)

(72) GU XING LONG, Concession GU, Quartier
Adjakè, Abomey -Calavi, Face U.A.C., 01 B.P.
4523, B.P. , COTONOU (BJ).

(11) **04346**

(21) 4201400276

(22) 19.08.2014

(51) 21

(54) Jeu.

(55)



1.1

(71) METSAM Edward Kennedy, s/c NZADI
TCHASSEM Jimmy, B.P. 34864 , YAOUNDE
(CM).

(11) **04347**

(21) 4201400278

(22) 20.08.2014

(30) KR n° KR 30-2014-0008995 du 21/02/2014

(51) 14

(54) Set comprising a sequence of generated images for display screens or portions thereof.

(55)



1.3



1.1



1.4



1.2

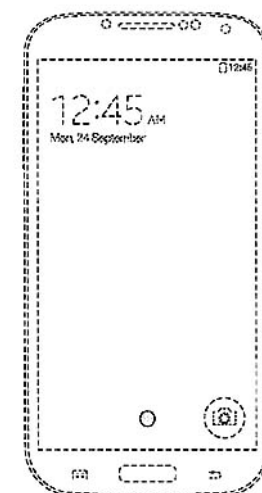

1.5

(55)



1.6



1.7



1.1



2.1

(71) Samsung Electronics Co., Ltd., 129, Samsung-ro, Yeongtong-gu, SUWON-SI 443-742, Gyeonggi-Do, (KR)

(72) LEE, Jae-Myoung, 721, Seocho EO Vill, 45, Hyoryeong-ro 53-gil, Seocho-gu, SEOUL 137-963 (KR); AHN, Ji-Hyun, 202, the michelan, 91, Myeongdal-ro, Seocho-gu, SEOUL 137-870 (KR)

(74) SCP AKKUM, AKKUM & Associates, Quartier Mballa II, Dragages, B.P. 4966, YAOUNDE (CM).

(71) SIVOP, 01 B.P. 2085, 01 ABIDJAN 01 (CI).

(11) **04348**

(21) 4201400280

(22) 13.08.2014

(51) 9

(54) Emballage pour produits cosmetiques.

(11) **04350**

(21) 4201400282

(22) 29.07.2014

(51) 20

(54) Equipement de vente ou de publicité, signes indicateurs.

(55)

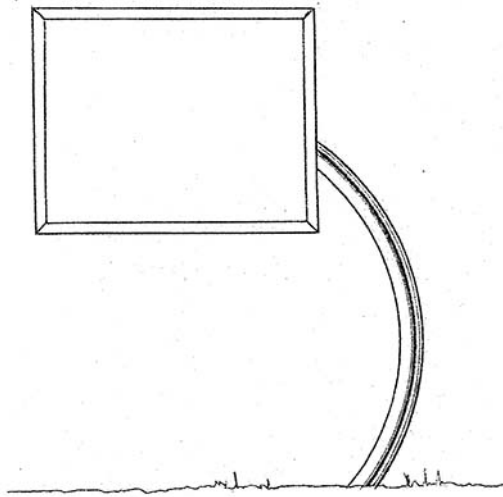

1.1

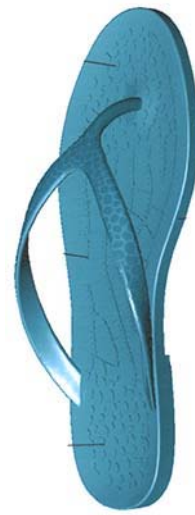

1.2

(71) GADEAU Marie - Stella, 01 B.P. 1343, ABIDJAN 01 (CI).

(11) **04351**

(21) 4201400283

(22) 13.08.2014

(51) 2

(54) Chaussure plastique.

(55)



1.3



1.1



2.1



2.2



3.2



2.3



3.3



3.1

(71) SIF - PLAST - CI, 15 B.P. 774, ABIDJAN 15 (CI).

(11) **04352**

(21) 4201400284

(22) 19.05.2014

(51) 23

(54) Installations pour la distribution de fluides.

(55)



1.1

(71) BEHANZIN Aurel Ferdinand Kenneth, 03 B.P. 1701, COTONOU (BJ).



1.2

(11) **04353**

(21) 4201400290

(22) 18.08.2014

(51) 2

(54) Chaussures plastiques.

(55)



1.3

(71) WIM PLAST, 16 B.P. 1777, ABIDJAN 16 (CI).



1.1

(11) **04354**

(21) 4201400291

(22) 30.07.2014

(51) 9

(54) Emballages.

(55)



1.1



2.1



3.1

(71) « Kanea professional cosmetics » en abrégé « K.P.C », Abidjan-17 rue des foreurs Zone 3, 26 B.P. 618, ABIDJAN 26 (CI)

(72) Mme N'GUYEN Nathalie Thérèse Gabrielle épouse KASSEM, 26 B.P. 618, ABIDJAN 26 (CI)

(74) Etude de Maître SIDIBE AKA-ANGHUI Diamilatou, Notaire, 06 B.P. 2438, ABIDJAN 06 (CI).

(11) **04355**

(21) 4201400292

(22) 21.07.2014

(51) 2

(54) Chaussure.

(55)



1.1



1.2

(71) SOGET - CI, 21 B.P. 1382, ABIDJAN 21 (CI).

(11) **04356**

(21) 4201400293

(22) 16.07.2014

(51) 2

(54) Chaussure plastique.

(55)



1.1



1.2



2.1



2.2

(71) KJ PLAST SARL, 15 B.P. 121, ABIDJAN 15 (CI).

(11) **04359**

(21) 4201400299

(22) 22.08.2014

(51) 2

(54) Chaussures.

(55)



1.1



1.2



2.1

(71) Société IDCOM-GUINEE sarl, Madina marché, Commune de Matam, 030 B.P. 607, CONAKRY (GN).



2.1

(71) Monsieur BAH Boubacar, Madina, Commune de Matam, B.P. 610 , CONAKRY (GN).

(11) **04361**

(21) 4201400302

(22) 28.08.2014

(51) 2

(54) Chaussures.

(55)

(11) **04360**

(21) 4201400300

(22) 28.08.2014

(51) 9

(54) Emballage et récipient pour le transport ou la manutention des marchandises.

(55)



1.1



1.1



2.1

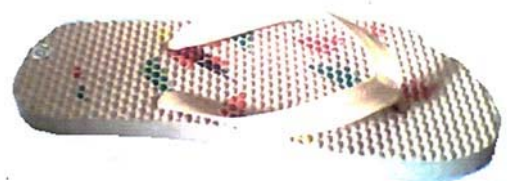

3.1



4.1



5.1



6.1



7.1



8.1

(71) Monsieur BAH Boubacar, Madina, Commune de Matam, B.P. 6283, CONAKRY (GN).

(11) **04362**

(21) 4201400303

(22) 21.08.2014

(51) 9

(54) Emballages et récipients pour le transport ou la manutention des marchandises; bouteilles.

(55)



1.1

(71) La SOCIETE RITCO SARL, Quartier Boma, Commune Urbaine, B.P. 280, N'ZEREKORE (GN).

(11) **04363**

(21) 4201400306

(22) 03.09.2014

(51) 9

(54) Emballages et récipients (bouteilles - flacons - pots).

(55)



1.1



2.1



5.1



3.1



6.1



4.1



7.1



8.1



11.1



9.1



12.1



10.1



13.1



14.1



17.1



15.1



18.1



16.1



19.1



20.1



23.1



21.1

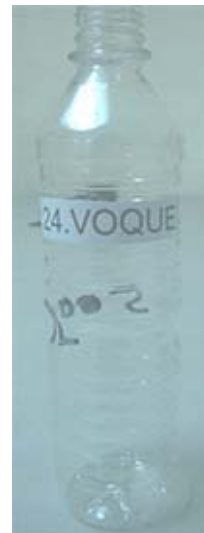

24.1



22.1



25.1



26.1



29.1



27.1



30.1



28.1



31.1



32.1



35.1



33.1



36.1



34.1



37.1



38.1



41.1



39.1



42.1



40.1



43.1



44.1



47.1



45.1



48.1



46.1

(71) SECOS INDUSTRIE SARL, Zone Industrielle Sodida Lot n° 106, B.P. 3945, DAKAR (SN)

(72) DIOUM Souhaybou, Zone Industrielle Sodida Lot n° 106, B.P. 3945, DAKAR (SN).

(11) **04364**

(21) 4201400307

(22) 06.08.2014

(51) 2

(54) Chaussures.

(55)



1.1



2.2



1.2



3.1



2.1



3.2



4.1



1.1



4.2



1.2

(71) ON DJARAMA, SARL, Bairro Mindara / Estrada de Cabana, BISSAU (GW).

(71) ETS CHANA - PLAST, 26 B.P. 940, ABIDJAN 26 (CI).

(11) **04365**

(21) 4201400309

(22) 11.09.2014

(51) 2

(54) Chaussure plastique.

(11) **04366**

(21) 4201400310

(22) 12.09.2014

(51) 2

(54) Chaussure plastique.

(55)

(55)



1.1



2.1



1.2



2.2



1.3



3.1

(71) ELEPHANT PLAST - CI, 17 B.P. 462, ABIDJAN 17 (CI).

(11) **04367**

(21) 4201400311

(22) 12.09.2014

(51) 9

(54) Symboles graphiques et logos, motifs décoratifs pour surfaces, ornementation.

(55)



1.1



2.1



3.1



4.1



5.1



6.1

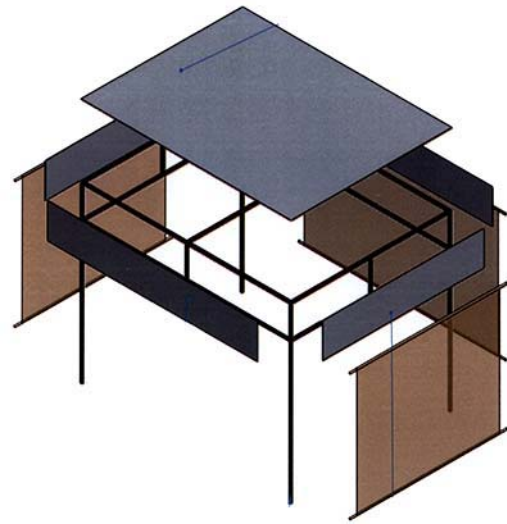

1.2

(71) ETS AT PLAST, 10 B.P. 1889, ABIDJAN 10 (CI).

(11) **04368**

(21) 4201400313

(22) 30.09.2014

(51) 21

(54) Structure de la tente en tube acier carré recouvert d'une peinture poudre; l'habillage du toit et des faces est en polypropylène alvéolaire de 5mm d'épaisseur ou du PVC expansé.

(55)

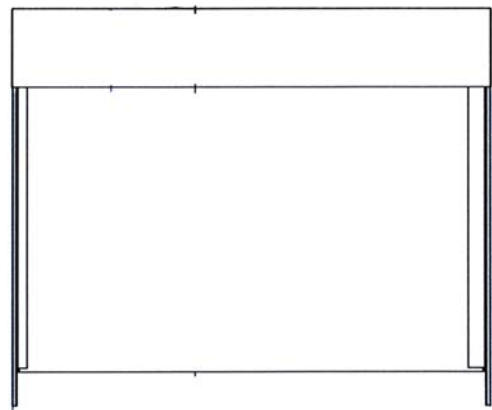

1.3



1.1

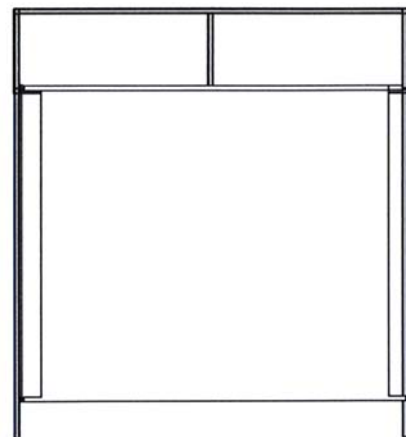

1.4

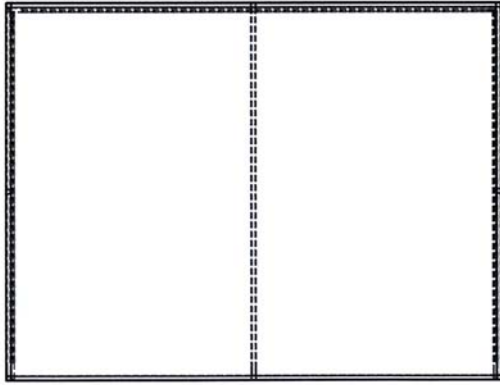

1.5

(71) M. TANKOU François Xavier, B.P. 5238 ,
DOUALA (CM).



2.1

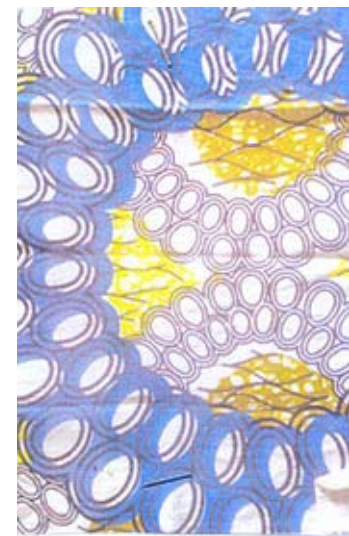

3.1

(11) **04369**

(21) 4201400316

(22) 24.09.2014

(51) 5

(54) Tissus.

(55)



1.1



4.1



5.1



8.1

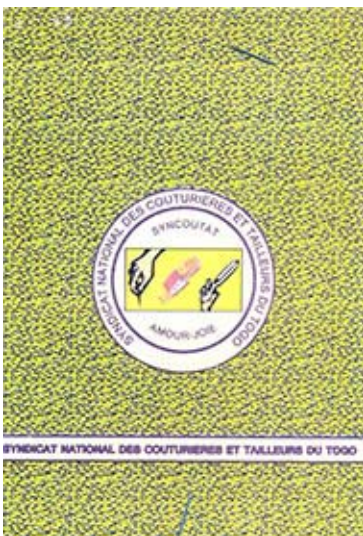

6.1



9.1



7.1



10.1

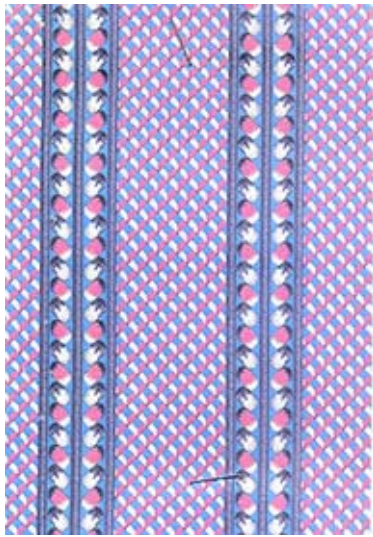

11.1



12.1

(71) Société Jesus Marie Joseph (JMJ), 02 B.P. 20378, LOME (TG)

(72) ALI - HOUNKPE Edoh Adjossa, 02 B.P. 378, LOME (TG).

(11) **04370**

(21) 4201400196

(22) 26.06.2014

(51) 3

(54) Sacs à main.

(55)



1.1



2.1



3.1



4.1



7.1



5.1



8.1



6.1



9.1



10.1



13.1



11.1



14.1



12.1



15.1



16.1



19.1



17.1



20.1



18.1



21.1



22.1



25.1



23.1



26.1



24.1



27.1



28.1



31.1



29.1



32.1



30.1



33.1



34.1



37.1



35.1



38.1



36.1



39.1

(71) SOCIETE T & J SARL, 01 B.P. 4523, COTONOU (BJ)

(72) GU XING LONG, Concession GU, Quartier Adjakè, Abomey-Calavi, Face U.A.C., 01 B.P. 45 23, COTONOU (BJ).