

Bulletin Officiel de la Propriété Industrielle (BOPI)

Brevets d'inventions

PUBLICATION

N° 10 BR / 2015

du 29 Avril 2016

Organisation
Africaine de la
Propriété
Intellectuelle



SOMMAIRE

TITRE	PAGES
PREMIERE PARTIE : GENERALITES	2
Extrait de la norme ST3 de l'OMPI utilisée pour la représentation des pays et organisations internationales	3
Extrait de la norme ST9 de l'OMPI utilisée en matière de documentation des Brevets d'Invention et des Modèles d'Utilité	6
Codes utilisés en matière d'inscriptions dans les registres spéciaux des Brevets d'Invention et des Modèles d'Utilité	6
Clarification du règlement relatif à l'extension des droits suite à une nouvelle adhésion à l'Accord de Bangui	7
Adresses utiles	8
DEUXIEME PARTIE : BREVETS D'INVENTION	9
Repertoire numérique du N° 17266 au N° 17315	10
Repertoire suivant la C.I.B	34
Repertoire des noms	36

**PREMIERE PARTIE
GENERALITES**

Extrait de la norme ST.3 de l'OMPI

Code normalisé à deux lettres recommandé pour la représentation des pays ainsi que d'autres entités et des organisations internationales délivrant ou enregistrant des titres de propriété industrielle.

Afghanistan	AF	Cook, Îles	CK
Afrique du Sud	ZA	Corée (République de Corée)	KR
Albanie	AL	Corée (Rép. Populaire de Corée)	KP
Algérie	DZ	Costa Rica	CR
Allemagne	DE	Côte d'Ivoire*	CI
Andorre	AD	Croatie	HR
Angola	AO	Cuba	CU
Anguilla	AI	Danemark	DK
Antigua-et-Barbuda	AG	Djibouti	DJ
Antilles Néerlandaises	AN	Dominicaine, République	DO
Arabie Saoudite	SA	Dominique	DM
Argentine	AR	Egypte	EG
Arménie	AM	El Salvador	SV
Aruba	AW	Emirats Arabes Unis	AE
Australie	AU	Equateur	EC
Autriche	AT	Erythrée	ER
Azerbaïdjan	AZ	Espagne	ES
Bahamas	BS	Estonie	EE
Bahreïn	BH	Etats-Unis d'Amérique	US
Bangladesh	BD	Ethiopie	ET
Barbade	BB	Ex Rep. Yougoslavie de Macedoine	MK
Bélarus	BY	Falkland, Îles (Malvinas)	FK
Belgique	BE	Fédération de Russie	RU
Belize	BZ	Fidji	FJ
Bénin*	BJ	Féroé, Îles	FO
Bermudes	BM	Finlande	FI
Bhoutan	BT	France	FR
Bolivie	BO	Gabon*	GA
Bonaire, Saint-Eustache et Saba	BQ	Gambie	GM
Bosnie-Herzégovine	BA	Géorgie	GE
Botswana	BW	Géorgie du Sud et les Îles Sandwich du Sud	GS
Bouvet, Île	BV	Ghana	GH
Brésil	BR	Gibraltar	GI
Brunéi Darussalam	BN	Grèce	GR
Bulgarie	BG	Grenade	GD
Burkina Faso*	BF	Groenland	GL
Burundi	BI	Guatemala	GT
Caïmanes, Îles	KY	Guernesey	GG
Cambodge	KH	Guinée*	GN
Cameroun*	CM	Guinée-Bissau*	GW
Canada	CA	Guinée Equatoriale*	GQ
Cap-Vert	CV	Guyana	GY
Centrafricaine, République*	CF	Haïti	HT

Chili	CL	Honduras	HN
Chine	CN	Hong Kong	HK
Chypre	CY	Hongrie	HU
Colombie	CO	Île de Man	IM
Comores*	KM	Îles Vierges (Britanniques)	VG
Congo*	CG	Inde	IN
Congo(Rép.Démocratique)	CD	Indonésie	ID
Iran(République Islamique d')	IR	Norvège	NO
Iraq	IQ	Nouvelle-Zélande	NZ
Irlande	IE	Oman	OM
Islande	IS	Ouganda	UG
Israël	IL	Ouzbékistan	UZ
Italie	IT	Pakistan	PK
Jamaïque	JM	Palaos	PW
Japon	JP	Panama	PA
Jersey	JE	Papouasie-Nouvelle-Guinée	PG
Jordanie	JO	Paraguay	PY
Kazakhstan	KZ	Pays-Bas	NL
Kenya	KE	Pérou	PE
Kirghizistan	KG	Philippines	PH
Kiribati	KI	Pologne	PL
Koweït	KW	Portugal	PT
Laos	LA	Qatar	QA
Lesotho	LS	Région admin. Spéciale de Hong Kong (Rep. Populaire de Chine)	HK
Lettonie	LV	Roumanie	RO
Liban	LB	Royaume Uni (Grande Bretagne)	GB
Libéria	LR	Rwanda	RW
Libye	LY	Sahara Occidental	EH
Liechtenstein	LI	Sainte-Hélène	SH
Lituanie	LT	Saint-Kitts-et-Nevis	KN
Luxembourg	LU	Sainte-Lucie	LC
Macao	MO	Saint-Marin	SM
Macédoine	MK	Saint-Marin (Partie Néerlandaise)	SX
Madagascar	MG	Saint-Siège(Vatican)	VA
Malaisie	MY	Saint-Vincent-et-les Grenadines(a,b)	VC
Malawi	MW	Salomon, Îles	SB
Maldives	MV	Samoa	WS
Mali*	ML	SaoTomé-et-Principe	ST
Malte	MT	Sénégal*	SN
Mariannes du Nord, Îles	MP	Serbie	RS
Maroc	MA	Seychelles	SC
Maurice	MU	Sierra Leone	SL
Mauritanie*	MR	Singapour	SG
Mexique	MX	Slovaquie	SK
Moldova	MD	Slovénie	SI
Monaco	MC	Somalie	SO

Mongolie	MN	Soudan	SD
Monténégro	ME	SriLanka	LK
Montserrat	MS	Suède	SE
Mozambique	MZ	Suisse	CH
Myanmar(Birmanie)	MM	Suriname	SR
Namibie	NA	Swaziland	SZ
Nauru	NR	Syrie	SY
Népal	NP	Tadjikistan	TJ
Nicaragua	NI	Taiwan,Province de Chine	TW
Niger*	NE	Tanzanie (Rép.-Unie)	TZ
Nigéria	NG	Tchad*	TD
Thaïlande	TH	Tchèque,République	CZ
Timor Oriental	TP	Ukraine	UA
Togo*	TG	Uruguay	UY
Tonga	TO	Vanuata	VU
Trinité-et-Tobago	TT	Venezuela	VE
Tunisie	TN	VietNam	VN
Turkménistan	TM	Yémen	YE
Turks et Caïques,Îles	TC	Yougoslavie	YU
Turquie	TR	Zambie	ZM
Tuvalu	TV	Zimbabwe	ZW

ORGANISATIONS INTERNATIONALES DELIVRANT OU ENREGISTRANT DES TITRES DE PROPRIETE INDUSTRIELLE

Bureau Benelux des marques et des dessins et modèles industriels	BX
Office Communautaire des variétés végétales (Communauté Européenne (OCVV))	QZ
Office de l'harmonisation dans le marché intérieur (Marque, dessins et modèles)	EM
Office des Brevets du conseil de Coopération des Etats du Golf (CCG)	GC
Office Européen des Brevets (OEB)	EP
Organisation Mondiale de la Propriété Intellectuelle (OMPI)	WO
Bureau International de l'OMPI	IB
Organisation Africaine de la Propriété Intellectuelle (OAPI)	OA
Organisation Eurasienne des Brevets (OEAB)	EA
Organisation Régionale Africaine de la Propriété Industrielle (ARIPO)	AP

*Etats membres de l'OAPI

**CODES UTILISES EN MATIERE DE DOCUMENTATION DES
BREVETS D'INVENTION ET DES MODELES D'UTILITE**

- (11) Numéro de publication.
- (12) Désignation du type de document.
- (19) Identification de l'office qui publie le document.
- (21) Numéro d'enregistrement ou de dépôt.
- (22) Date de dépôt.
- (24) Date de délivrance.
- (30) Pays dans lequel (lesquels) la(les) demande(s) de priorité a (ont) été déposée(s).
Date(s) de dépôt de la (des) demande(s) de priorité.

(le cas échéant)

Numéro(s) attribué(s) à la (aux) demande(s) de priorité.

- (51) Classification internationale des brevets(CIB).
- (54) Titre de l'invention.
- (57) Abrégé.
- (60) Références à d'autres documents apparentés (le cas échéant).
- (71) Nom(s) du ou des demandeur(s).
- (72) Nom de l'inventeur (le cas échéant) suivi éventuellement du nom de la société d'appartenance.
- (73) Nom(s) du ou des titulaire(s) le cas échéant.
(Ce code n'apparaît que sur la première page du brevet délivré)
- (74) Nom du mandataire en territoire OAPI (le cas échéant).

**CODES UTILISES EN MATIERE D'INSCRIPTIONS
DANS LE REGISTRE SPECIAL DES BREVETS D'INVENTION ET DES
MODELES D'UTILITE**

- (1) Numéro de délivrance
- (2) Numéro de dépôt
- (3) Numéro et date de la demande d'inscription
- (4) Nature de l'inscription
- (5) Numéro et date de l'inscription
- (10) Cédant
- (11) Cessionnaire
- (12) Apporteur
- (13) Bénéficiaire
- (14) Dénomination avant
- (15) Dénomination après
- (16) Concédant
- (17) Titulaire
- (18) Ancienne adresse
- (19) Nouvelle adresse
- (20) Constituant du nantissement
- (21) Créancier nanti

CLARIFICATION DU REGLEMENT RELATIF A L'EXTENSION DES DROITS SUITE A UNE NOUVELLE ADHESION A L'ACCORD DE BANGUI

RESOLUTION N°47/32

LE CONSEIL D'ADMINISTRATION DE L'ORGANISATION AFRICAINE DE LA PROPRIETE INTELLECTUELLE

- Vu L'accord portant révision de l'accord de Bangui du 02 Mars 1977 instituant une Organisation Africaine de la Propriété Intellectuelle et ses annexes ;
- Vu Les dispositions des articles 18 et 19 dudit Accord relatives Aux attributions et pouvoirs du Conseil d'Administration ;

ADOPTE la clarification du règlement du 04 décembre 1988 relatif à l'extension des droits suite à une nouvelle adhésion à l'Accord de Bangui ci-après :

Article 1er :

Le Règlement du 04 décembre 1988 relatif à l'extension des droits suite à une nouvelle adhésion à l'Accord de Bangui est réaménagé ainsi qu'il suit :

« Article 5 (nouveau) » :

Les titulaires des titres en vigueur à l'Organisation avant la production des effets de l'adhésion d'un Etat à l'accord de Bangui ou ceux dont la demande a été déposée avant cette date et qui

voudront étendre la protection dans ces Etats doivent formuler une demande d'extension à cet effet auprès de l'Organisation suivant les modalités fixées aux articles 6 à 18 ci-dessous.

Le renouvellement de la protection des titres qui n'ont pas fait l'objet d'extension avant l'échéance dudit renouvellement entraîne une extension automatique des effets de la protection à l'ensemble du territoire OAPI».

Le reste sans changement.

Article 2 :

La présente clarification, qui entre en vigueur à compter du 1^{er} janvier 2008, s'applique aussi aux demandes d'extension en instance et sera publiée au Bulletin Officiel de l'Organisation.

Fait à Bangui le 17 décembre 2007

STRUCTURES NATIONALES DE LIAISON (SNL)

BENIN-Cotonou

Agence Nationale de la Propriété Industrielle (ANAPI)

Tel.: (229) 21 31 02 40
Fax.: (229) 21 30 30 24
01 B.P. 363 Cotonou 01

BURKINA FASO-Ouagadougou

Direction Nationale de la Propriété Industrielle (DNPI)

(Ministère de l'Industrie, du Commerce et de l'Artisanat)
Tél. : (226) 50 30 09 41
Fax : (226) 50 33 05 63
01 B.P. 258 Ouagadougou

CAMEROUN-Yaoundé

Direction du Développement Technologique et de la Propriété Industrielle

(Ministère des Mines, de l'Industrie et du Développement Technologique)
Tel. : (237) 22 20 37 78
Fax: (237) 22 20 37 38
B.P. 1652 Yaoundé

CENTRAFRIQUE-Bangui

Direction de la Propriété Industrielle (Ministère du Commerce et de l'Industrie)

Tél. : (236) 21 61 17 44
Fax : (236) 21 61 76 53
Avenue B. BOGANDA
B.P. 1988 Bangui

COMORES-Moroni

Office comorien de la propriété intellectuelle

Tél. : 269 333 53 60
Fax : 269 775 00 03
B.P. 41 Moroni

CONGO-Brazzaville

Antenne Nationale de la Propriété Industrielle (ANPI)

(Ministère du Développement Industriel et de la Promotion du Secteur Privé)
Tél. : (242) 581 56 57
Fax : (242) 581 54 80
B.P. : 72 Brazzaville

COTE D'IVOIRE-Abidjan

Office Ivoirien de la Propriété Industrielle (OIPD)

Tel. : (225) 20 33 53 43/44
Fax: (225) 20 33 53 45
01 B.P. 2337 Abidjan

GABON-Libreville

Centre de la Propriété Industrielle du Gabon (CEPIG)

(Ministère du Commerce et du Développement Industriel, Chargé du NEPAD)
Tel. : (241) 01 74 59 24
Fax : (241) 01 76 30 55
B.P. : 1025 Libreville

GUINEE-Conakry

Service National de la Propriété Industrielle

(Ministère de l'Industrie, des Petites et Moyennes Entreprises)
Tel. : (224) 30 41 17 20/60 58 53 61
Fax: (224) 41 25 42/41 39 90
B.P. 468 Conakry

GUINEE BISSAU-Bissau

Direction Générale de la Propriété Industrielle

(Ministère du Commerce, de l'Industrie et de la Promotion des Produits locaux)
Tél : (245) 322 22 75
Fax : (245) 322 37 65
B.P. : 269 Bissau

GUINEE EQUATORIALE-Malabo

Direction de la Propriété Intellectuelle

(Conseil de la Recherche Scientifique et Technique - CICTE)
Tel. : (240) 222 09 24 84
Fax : (240) 333 09 33 13
B.P. : 528 Malabo

MALI-Bamako

Centre Malien de la Propriété Industrielle (CEMAPI)

Tel. : (223) 20 29 90 90
Fax: (223) 20 29 90 91
B.P. : 278 Bamako

MAURITANIE-Nouakchott

Service de la Technologie et de la Propriété Industrielle

(Ministère du Commerce, de l'Industrie, de l'Artisanat et du Tourisme)
Tel. : (222) 525 72 66
Fax: (222) 525 69 37
B.P. : 387 Nouakchott

NIGER-Niamey

Direction de l'Innovation et de la Propriété Intellectuelle

(Ministère des Mines et du Développement Industriel)
Tél. : (227) 20 73 58 25
Fax : (227) 20 73 21 50
B.P. : 480 Niamey

SENEGAL-Dakar

Agence Sénégalaise pour la Propriété Industrielle et l'Innovation Technologique (ASPIT)

Tel. : (221) 33 869 47 70
Fax: (221) 33 827 30 14
B.P. : 4037 Dakar

TCHAD-N'djamena

Division de la Propriété Industrielle et de la Technologie (Ministère du Commerce et de l'Industrie)

Tel. : (235) 22 52 08 67
Fax: (235) 22 52 21 79
B.P. : 424 N'Djamena

TOGO-Lomé

Institut National de la Propriété Industrielle et de la Technologie (INPIT)

Tel. : (228) 222 10 08
Fax : (228) 222 44 70
B.P. : 2339 Lomé



OAPI

B.P. 887 Yaoundé-Cameroun Tél : (237) 22 20 57 00

E-mail : oapi@oapi.int

Fax : (237) 22 20 57 27

www.oapi.int

DEUXIEME PARTIE
BREVETS D'INVENTION

A
REPertoire NUMERIQUE
du 17266 au N° 17315

(11) 17266

(51) A61P 27/02

(21) 1200900426

(22) 08.12.2009

(54) Produit naturel cicatrisant des brûlures corporelles.

(72) TCHIKA-MITTORI Gilbert

(73) TCHIKA-MITTORI Gilbert, 165 bis Avenue de l'indépendance, Quartier Mahouata, POINTE-NOIRE (CG).

(57) Produit naturel cicatrisant des brûlures corporelles 1er et 2e degré. Dénommée : brul-mit (poudre). L'invention concerne un produit naturel cicatrisant des brûlures corporelles obtenu à base d'une plante de nom scientifique Manihot Esculenta Crantz. Il contient quatre principes actifs (antalgique et inflammatoire - absorbant et cicatrisant). En effet, les feuilles de Manihot Esculenta Crantz sont préalablement séchées pendant 48 heures ou 72 heures. Maximum puis macérées et débarrassées de pétioles. Ensuite, le produit est placé au four sous une température comprise de 25°C ou 30°C. Au bout de 5 à 10 minutes, il est retiré du four, puis broyé, tamisé et conditionné dans un emballage approprié.

[Consulter le mémoire](#)**(11) 17267**

(51) A61P 9/00

(21) 1201200527

(22) 15.10.2014

(54) Fabrication d'un sirop à base d'escargot pour les problèmes cardio-neurologiques.

(72) YESSOUFOU ADIDJATOU

(73) YESSOUFOU ADIDJATOU, 05 B.P. 2498, COTONOU (BJ).

(57) Le sirop à base d'escargot est constitué de la chair d'escargot bien cuite et moulue mélangée à de l'eau, du sucre dans une certaine proportion puis à du jus de citron le tout laissé sur le feu pendant au minimum une heure. Il permet de traiter efficacement les problèmes cardio-

neurologiques, rajeunit le sujet qui le prend souvent pour l'entretien de l'organisme.

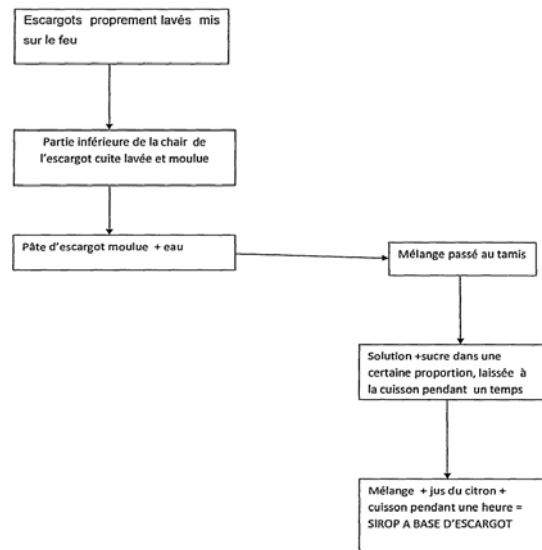
[Consulter le mémoire](#)**(11) 17268**

(51) F16L 15/04 (06.01)

(21) 1201300185 - PCT/JP11/076016

(22) 04.11.2011

(30) JP n° 2010-248790 du 05/11/2010

(54) Tubular threaded joint having improved high torque performance.

(72) GOTO, Kunio;

YAMAMOTO, Yasuhiro.

(73) Nippon Steel & Sumitomo Metal Corporation (JP);

Vallourec Mannesmann Oil & Gas France (FR).

(74) Cabinet Spoor & Fisher Inc. Ngwafor & Partners, Blvd. du 20 Mai, Immeuble Centre Commercial de l'Hôtel Hilton, 2è Etage, Porte 208A, P.O. Box 8211, YAOUNDE (CM).

(57) A lubricating coating which can prevent the occurrence of galling even when makeup is carried out with a high torque and which has excellent rust preventing properties is formed on the contact surfaces of a pin and/or a box of a tubular threaded joint. The lubricating coating contains copolymer particles made from particles of an acrylic-silicone copolymer with an average particle diameter of 10 - 50 µm dispersed in a highly viscous matrix made from a mixture of a rosin-based substance selected from rosin and its

derivatives, wax, a metal soap, and a basic metal salt of an aromatic organic acid (such as highly basic Ca sulfonate).

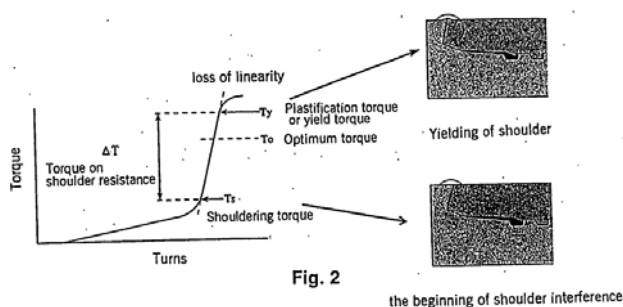

[Consulter le mémoire](#)

(11) **17269**

(51) G06F 17/30 (06.01)

(21) 1201400032 - PCT/CN12/076767

(22) 12.06.2012

(30) CN n° 2011102048796 du 21/07/2011

(54) Index constructing method, search method, device and system.

(72) MA, Chao;

SHEN, Yan;

ZHU, Zhengping.

(73) Tencent Technology (Shenzhen) Company Limited (CN)

(74) Cabinet Spoor & Fisher Inc. Ngwafor & Partners, Blvd. du 20 Mai, Immeuble Centre Commercial de l'Hôtel Hilton, 2è Etage, Porte 208A, P.O. Box 8211, YAOUNDE (CM).

(57) The present disclosure discloses an index constructing method, search method, device and system. The index constructing method includes : constructing data obtained in each preset time period into a primary index segment, respectively, and merging the constructed primary index segments into a primary index segment set after each preset time period is over; copying and merging each primary index segment in the primary index segment set into a corresponding large index segment, to obtain a large index segment set; and sending the primary index segments in the primary index segment set or the large index segment in the large index segment set ; and sending the primary index segments set or the large index segments in the large index segment set to a search device to provide a search service. The present disclosure constructs the primary index segments on the basis of the,

merges the constructed primary index segments into large index segments, and provides the search service simultaneously with the primary index segment or the large index segments, thus, improving search speed.

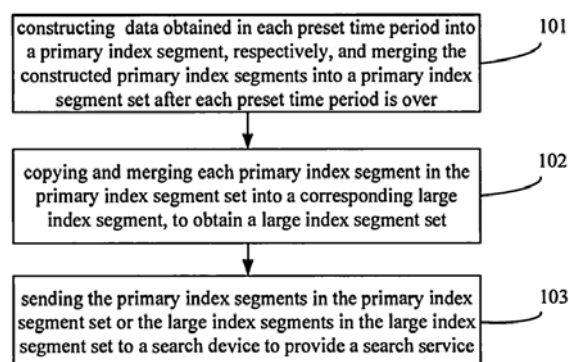

[Consulter le mémoire](#)

(11) **17270**

(51) C05F 7/00

(21) 1201400350 - PCT/US13/023534

(22) 29.01.2013

(30) US n° 61/633,018 du 03/02/2012

(54) Systems and methods for converting and processing organic sludges for multi-nutrient single accreted granule enhanced efficiency fertilizer production.

(72) Tuttle, Roger E.;

Weber, David A.;

Moran, W., Dennis.

(73) Unity Fertilizer LLC (US)

(74) Cabinet Spoor & Fisher Inc. Ngwafor & Partners, Blvd. du 20 Mai, Immeuble Centre Commercial de l'Hôtel Hilton, 2è Etage, Porte 208A, P.O. Box 8211, YAOUNDE (CM).

(57) Converting dewatered heterogeneous sludge containing organic waste materials into a homogenous extract of carbon and amino acids for fertilizer production by adding sulfuric acid to the sludge; pumping the mixture through a blending mixer to mix the sludge with the sulfuric acid; adding conditioning chemicals to the mixture: pumping the mixture through a shearing mixer to mix the conditioning chemicals into the mixture; and mechanically agitating the mixture to create the homogenous extract. Optionally, the extract is pumped into a pipe reactor for reaction

with an acid and a base to form a melt, which is rolled onto fertilizer particles to form accreted granules. The accreted granules are dried to form a granular fertilizer. Also described is an organically-enhanced granular nitrogen-phosphorous-sulfur fertilizer having at least about 0.5% by weight total carbon and amino acids, and accreted granule size greater than or equal to about 1.7 mm. The fertilizer is noncombustible.

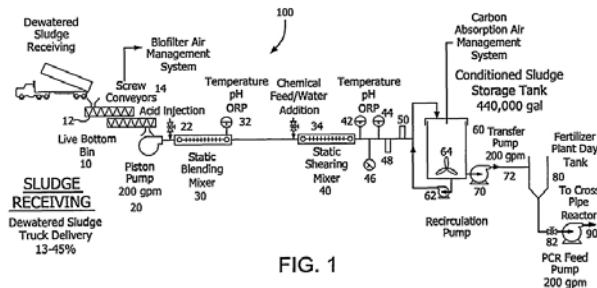

FIG. 1

[Consulter le mémoire](#)

(11) **17271**

(51) C21D 1/38; B23H 9/00; C23C 24/04

F16C 33/12; C21D 1/08

(21) 1201400371 - PCT/EP13/053092

(22) 15.02.2013

(30) EP n° 12155655.9 du 15/02/2012

(54) Localized hardening of metallic surfaces.

(72) KISLOV, Valentin;

KISLOV, Stanislav.

(73) LONGEVITY ENGINEERING SA (LU)

(74) SCP NICO HALLE & CO. LAW FIRM,
B.P. 4876, DOUALA (CM).

(57) The present invention relates to a method and system for treatment of a surface of a metallic material component, the method comprising the steps : electro-spark treating the surface of the metallic component by means of an electro-spark electrode, wherein the metallic material is a basically ferritic, perlitic and/or austenitic steel and the method creates a thin layer with martensitic microstructures at the surface of the metallic material component. Serpentes and quartz can be incorporated by an additional step as well as the surface randomly structured by this.

[Consulter le mémoire](#)

(11) **17272**

(51) G60Q 10/00 (06.01)

(21) 1201400544 - PCT/EP12/061661

(22) 19.06.2012

(54) Micro-resource-pooling system and corresponding method thereof.

(72) DA VICTORIA LOBO, Nikhil;

YOUNG, Simon.

(73) Swiss Reinsurance Company Ltd. (CH)

(74) Cabinet Spoor & Fisher Inc. Ngwafor & Partners, Blvd. du 20 Mai, Immeuble Centre Commercial de l'Hôtel Hilton, 2è Etage, Porte 208A, P.O. Box 8211, YAOUNDE (CM).

(57) The invention relates to a resource-pooling system (1) and to a corresponding method for risk sharing of a variable number of risk exposure components (21, 22, 23,...) by providing a self-sufficient risk protection for the risk exposure components (21, 22, 23,...) by means of the resource-pooling system (1). The risk exposure components (21, 22, 23,...) are connected to the resource-pooling system (1) by means of a plurality of payment receiving modules (2) configured to receive and store payments from risk exposure components (21, 22, 23,...) for the pooling of their risks. The total risk of the pooled risk exposure components (21, 22, 23,...) comprises a first risk contribution (211) associated to risk exposure in relation to loan losses, and a second risk contribution (212) associated to risk exposure based on emergency expenses. The pooled risk is divided in a parameterizable risk part (11) and a non-parameterizable risk part (21) by means of an indexing module. In case of triggering a loss by means of a trigger module, the suffered loss is covered by releasing associated loans and emergency expenses of the risk exposure components (21, 22, 23,...) based on the parameterizable risk part (11) from the connected loss coverage system (3) and based on the non-parameterizable risk part (12) from the received and stored payments from risk exposure components (21, 22, 23,...).

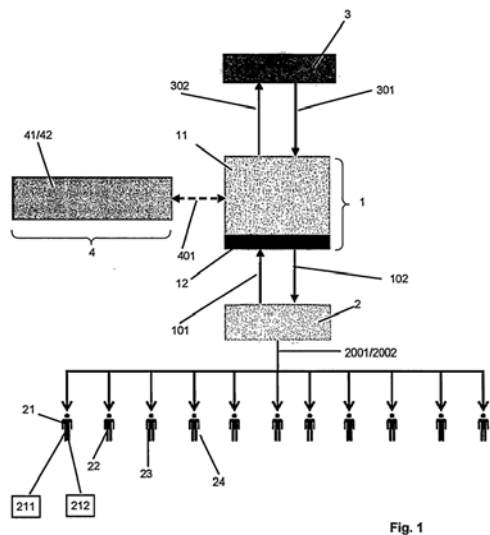

Fig. 1

[Consulter le mémoire](#)

(11) **17273**

(51) E21B 17/10 (06.01)

(21) 1201500002 - PCT/NO13/000031

(22) 10.07.2013

(30) NO n° 20120803 du 12/07/2012

NO n° 20121235 du 22/10/2012

NO n° 20130208 du 07/02/2013

(54) Device arranged for attaching a pipe stem on a tubular body.

(72) STEINE Ken Erik

(73) Ace Oil Tools AS (NO)

(74) Cabinet ÉKÉMÉ LYSAGHT SARL, B.P. 6370, YAOUNDE (CM).

(57) Attachment device for an element (1) made to be arranged on a downhole tubular body (3), in which an end portion (11) of a sleeve (1a) which is arranged to surround a portion of the tubular body (3) is provided with an attachment portion (13) which includes at least one clamping element (1312, 1312') arranged for axial displacement by the abutment of an abutment surface (1315) against a conical abutment portion (142) of a surrounding adapter sleeve (14).

Figure 3 shows, on a larger scale, an axial section through an attachment portion with an adapter sleeve formed as a nut screwed partially onto the attachment portion;

[Consulter le mémoire](#)

(11) **17274**

(51) E21B 32/12 (06.01)

(21) 1201500017 - PCT/CN12/079051

(22) 23.07.2012

(54) Liner hanger top packer.

(72) YI, Huian;

TIAN, Bingzhou;

CHEN, Shanyin;

DING, Baisong;

ZAN, Zhien;

LI, Boren;

LIU, Miaoren;

YE, Fangju;

YI, Qizun;

CHEN, Guangli.

(73) STARSE Energy and Technology (Group) Co., Ltd (CN);

YI, Huian (CN)

(74) Cabinet Spoor & Fisher Inc. Ngwafor & Partners, Blvd. du 20 Mai, Immeuble Centre Commercial de l'Hôtel Hilton, 2è Etage, Porte 208A, B.P. 8211, YAOUNDE (CM).

(57) A liner hanger top packer comprising a main body (10) and, sleeved sequentially from top to bottom on the main body, an adjusting sleeve (20), a retaining apparatus (30), a base-sealing apparatus (40), a base-hanging apparatus (50), and a locking mechanism (60) arranged between the base-sealing apparatus (40) and the base-hanging apparatus (50). The locking mechanism (60) comprises a locking ball sleeve (61), a ball socket (62), and a steel ball (63). During a descent process, as the lower part of the liner hanger top packer is met with friction, the arrangement of the steel ball (63) restricts relative axial movements between an upper gauge ring (41) of the base-sealing apparatus (40), the locking ball sleeve (61), and an upper conical body (51) of the base-hanging apparatus (50), therefore, the friction transmitted to the upper conical body (51) is not transmitted to a lower gauge ring (43) of the base-sealing apparatus (40), but is transmitted directly to the upper gauge ring (41) via the steel ball (63), and is further transmitted to the adjusting ring (20) via the retaining apparatus (30). As such, relative movements are not generated between the upper

gauge ring (41) and the lower gauge ring (43), while a plastic cylinder (42) does not deform, thus preventing the possibility to premature base-sealing.

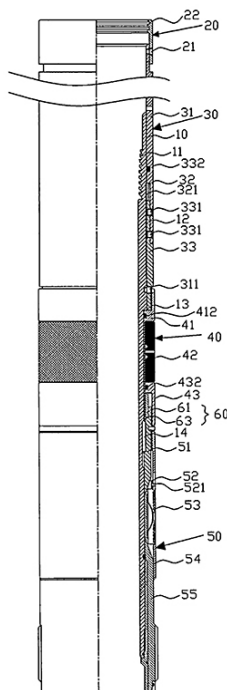

Fig. 1

[Consulter le mémoire](#)

(11) **17275**

(51) A01N 43/40

(21) 1201500024 - PCT/US13/051320

(22) 19.07.2013

(30) US n° 61/675,103 du 24/07/2012

US n° 13/839,043 du 15/03/2013

(54) Herbicidal compositions comprising 4-amino-3-chloro-5-fluoro-6-(4-chloro-2-fluoro-3-methoxyphenyl) pyridine-2-carboxylic acid.

(72) YERKES, Carla, N.;

SATCHIVI, Norbert;

MANN, Richard, K.;

CARRANZA GARZON, Nelson, M. (CO);

WEIMER, Monte, R.

(73) Dow AgroSciences LLC (US)

(74) Cabinet Spoor & Fisher Inc. Ngwafor & Partners, Blvd. du 20 Mai, Immeuble Centre Commercial de l'Hôtel Hilton, 2è Etage, Porte 208A, B.P. 8211, YAOUNDE (CM).

(57) Provided herein are synergistic herbicidal compositions containing and methods utilizing (a) a compound of formula (I)

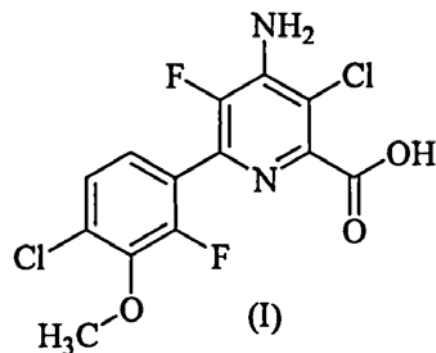

or an agriculturally acceptable salt or ester thereof and (b) an ACCase inhibitor, including, e.g., clethodim, clodinafop-propargyl, cyhalofop-R-butyl, diclofop-methyl, fenoxaprop-P-ethyl, fluazifop-P-butyl, haloxyfop-R-methyl, metamifop, pinoxaden, profoxydim, quizalofop-P-ethyl, sethoxydim and tralkoxydim, provide synergistic weed control of undesirable vegetation in rice, cereals, wheat, barley, oats, rye, sorghum, com/maize, sugarcane, sunflower, oilseed rape, canola, sugar beet, soybean, cotton, pineapple, pastures, grasslands, rangelands, fallowland, turf, tree and vine orchards, aquatics, plantation crops, vegetables, industrial vegetation management (IVM) or rights of way (ROW).

[Consulter le mémoire](#)

(11) **17276**

(51) A01N 43/40

(21) 1201500025 - PCT/US13/051323

(22) 19.07.2013

(30) US n° 61/675,117 du 24/07/2012

US n° 13/837,990 du 15/03/2013

(54) Herbicidal compositions comprising 4-amino-3-chloro-5-fluoro-6-(4-chloro-2-fluoro-3-methoxyphenyl) pyridine-2-carboxylic acid.

(72) MANN, Richard, K.;

YERKES, Carla, N.;

SATCHIVI, Norbert, M.;

SCHMITZER, Paul, R.

(73) Dow AgroSciences LLC (US)

(74) Cabinet Spoor & Fisher Inc. Ngwafor & Partners, Blvd. du 20 Mai, Immeuble Centre Commercial de l'Hôtel Hilton, 2è Etage, Porte 208A, B.P. 8211, YAOUNDE (CM).

(57) Provided herein are synergistic herbicidal compositions comprising (a) a compound of formula (I) :

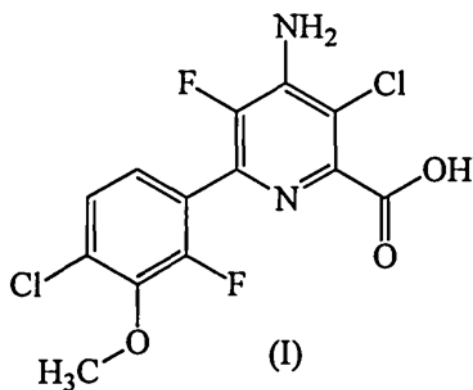

or an agriculturally acceptable salt or ester thereof and (b) a sulfonylurea e.g., amidosulfuron, azimsulfuron, bensulfuron-methyl, chlorsulfuron, cyclosulfuron, ethametsulfuron-methyl, ethoxysulfuron, flazasulfuron, flucetosulfuron, flupyrsulfuron-methyl sodium, foramsulfuron, imazosulfuron, iofensulfuron, iodosulfuron-methyl sodium, mesosulfuron-methyl, metsulfuron-methyl, nicosulfuron, orthosulfuron, primisulfuron-methyl, propyrisulfuron, prosulfuron, pyrimisulfan, pyroxasulfone, rimsulfuron, sulfometuron-methyl, sulfosulfuron, thifensulfuron-methyl, triafamone, triasulfuron, tribenuron-methyl or trifloxysulfuron-sodium, or an agriculturally acceptable salt or ester thereof. The compositions and methods provide control of undesirable vegetation, e.g., in crops and other settings, e.g., in direct-seeded, water-seeded and transplanted rice, cereals, wheat, barley, oats, rye, sorghum, corn or maize, sugarcane, sunflower, oilseed rape, canola, sugar beet, soybean, cotton, pineapple, pastures, grasslands, rangelands, fallowland, turf, tree and vine orchards, aquatics, plantation crops, vegetables, industrial vegetation management (IVM) or rights-of-way (ROW).

[Consulter le mémoire](#)

(11) **17277**

(51) A01N 43/40

(21) 1201500026 - PCT/US13/051322

(22) 19.07.2013

(30) US n° 61/675,109 du 24/07/2012

US n° 61/675,117 du 24/07/2012

US n° 13/833,362 du 15/03/2013

(54) Herbicidal compositions comprising 4-amino-3-chloro-5-fluoro-6-(4-chloro-2-fluoro-3-methoxyphenyl) pyridine-2-carboxylic acid.

(72) YERKES, Carla, N.;

MANN, Richard, K.

(73) Dow AgroSciences LLC (US)

(74) Cabinet Spoor & Fisher Inc. Ngwafor & Partners, Blvd. du 20 Mai, Immeuble Centre Commercial de l'Hôtel Hilton, 2è Etage, Porte 208A, B.P. 8211, YAOUNDE (CM).

(57) Provided herein are synergistic herbicidal compositions containing (a) a compound of formula (I) :

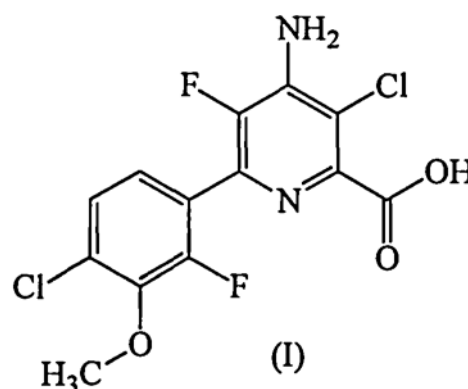

or an agriculturally acceptable salt or ester thereof and (b) dimethoxy-pyrimidine acids, including but not limited to bispyribac-sodium, pyribenzoxim, pyriftalid, pyriminobac-methyl and pyrimisulfan provide synergistic weed control of undesirable vegetation e.g., in direct seeded, water-seeded, and transplanted rice, cereals, wheat, barley, oats, rye, sorghum, corn or maize, sugarcane, sunflower, oilseed rape, canola, sugar beet, soybean, cotton, pineapple, vegetables, pastures, grasslands, rangelands, fallowland, turf, tree and vine orchards, aquatics, plantation crops, industrial vegetation management (IVM) or rights of way (ROW).

[Consulter le mémoire](#)

(11) **17278**

(51) A01N 43/40

(21) 1201500028 - PCT/US13/051327

(22) 19.07.2013

(30) US n° 61/675,110 du 24/07/2012

US n° 13/834,326 du 15/03/2013

(54) Herbicidal compositions comprising 4-amino-3-chloro-5-fluoro-6-(4-chloro-2-fluoro-3-methoxyphenyl) pyridine-2-carboxylic acid.

(72) YERKES, Carla, N.;

MANN, Richard, K.

(73) Dow AgroSciences LLC (US)

(74) Cabinet Spoor & Fisher Inc. Ngwafor & Partners, Blvd. du 20 Mai, Immeuble Centre Commercial de l'Hôtel Hilton, 2è Etage, Porte 208A, B.P. 8211, YAOUNDE (CM).

(57) Provided herein are synergistic herbicidal compositions containing and methods of controlling undesirable vegetation utilizing (a) a compound of formula (I) :

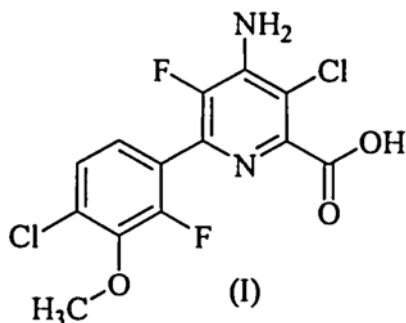

or an agriculturally acceptable salt or ester thereof and (b) halosulfuron-methyl, pyrazosulfuron-ethyl or esprocarb, or an agriculturally acceptable derivative thereof. The compositions and methods provided herein provide control of undesirable vegetation, e.g., in direct-seeded, water-seeded and transplanted rice, cereals, wheat, barley, oats, rye, sorghum, corn or maize, sugarcane, sunflower, oilseed rape, canola, sugar beet, soybean, cotton, pineapple, oilseed rape, vegetables, pastures, grasslands, rangelands, fallowland, turf, tree and vine orchards, aquatics, plantation crops, vegetables, industrial vegetation management (IVM) or rights of way (ROW).

[Consulter le mémoire](#)

(11) **17279**

(51) A01W 43/40

(21) 1201500030 - PCT/US13/051289

(22) 19.07.2013

(30) US n° 61/675,037 du 24/07/2012

US n° 13/832,978 du 15/03/2014

(54) Herbicidal compositions comprising 4-amino-3-chloro-5-fluoro-6-(4-chloro-2-fluoro-3-methoxyphenyl) pyridine-2-carboxylic acid.

(72) MANN, Richard, K.;

YERKES, Carla, N.;

SATCHIVI, Norbert, M.;

WEIMER, Monte, R.;

CARRANZA GARZON, Nelson, M.

(73) Dow AgroSciences LLC (US)

(74) Cabinet Spoor & Fisher Inc. Ngwafor & Partners, Blvd. du 20 Mai, Immeuble Centre Commercial de l'Hôtel Hilton, 2è Etage, Porte 208A, B.P. 8211, YAOUNDE (CM).

(57) Provided herein are synergistic herbicidal compositions containing (a) a compound of formula (I) :

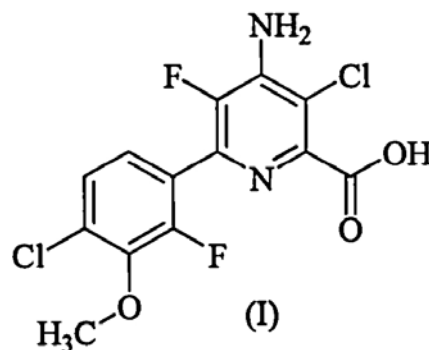

or an agriculturally acceptable salt or ester thereof and (b) triazolopyrimidine sulfonamides, including, but not limited to cloransulam-methyl, diclosulam, florasulam, flumetsulam, metosulam, penoxsulam and pyroxsulam. The compositions provide control of undesirable vegetation, e.g., in direct-seeded, water-seeded and transplanted rice, cereals, wheat, barley, oats, rye, sorghum, corn/maize, sugarcane, sunflower, oilseed rape, canola, sugar beet, soybean, cotton, pineapple, pastures, grasslands, rangelands, fallowland, turf, tree and vine orchards, aquatics, plantation crops, vegetables, industrial vegetation management (IVM) and rights of way (ROW).

[Consulter le mémoire](#)

(11) **17280**(51) A01N 43/40; A01N 43/06; A01N 43/707
A01N 37/34; A01N 47/30

(21) 1201500032 - PCT/US13/051297

(22) 19.07.2013

(30) US n° 61/675,089 du 24/07/2012

US n° 13/840,488 du 15/03/2013

(54) Herbicidal compositions comprising 4-amino-3-chloro-5-fluoro-6-(4-chloro-2-fluoro-3-methoxyphenyl) pyridine-2-carboxylic acid or a derivative thereof and certain PS II inhibitors.

(72) YERKES, Clara;

MANN, Richard;

SCHMITZER, Paul;

SATCHIVI, Norbert.

(73) Dow AgroSciences LLC (US)

(74) Cabinet Spoor & Fisher Inc. Ngwafor & Partners, Blvd. du 20 Mai, Immeuble Centre Commercial de l'Hôtel Hilton, 2è Etage, Porte 208A, B.P. 8211, YAOUNDE (CM).

(57) Provided herein are synergistic herbicidal compositions containing (a) a compound of formula (I) :

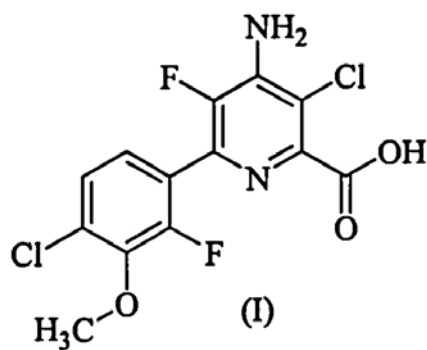

or an agriculturally acceptable salt or ester thereof and (b) a PS II inhibitor, including but not limited to, atrazine, bentazon-sodium, bromoxynil, chlorotoluron, cyanazine, diuron, hexazinone, ioxynil, isoproturon, linuron, methibenzuron, metribuzin, propanil, pyridate, siduron, simazine, simetryne, tebuthiuron and terbuthylazine, or a salt or ester thereof. The compositions and methods provided herein provide control of undesirable vegetation, e.g., in direct-seeded, water-seeded and transplanted rice, cereals, wheat, barley, oats, rye, sorghum, corn or maize, sugarcane, sunflower, oilseed rape, canola, sugar beet, soybean, cotton, pineapple, pastures, grasslands, rangelands, fallowland, turf, tree and

vine orchards, aquatics, plantation crops, vegetables, industrial vegetation management (IVM) or rights of way (ROW).

[Consulter le mémoire](#)

(11) **17281**(51) A61K 45/06; A61K 31/27; A61K 31/445
A61K 31/55; A61P 25/28

(21) 1201500075 - PCT/EP13/068516

(22) 06.09.2013

(30) US n° 61/698,664 du 09/09/2012

US n° 61/782,084 du 14/03/2013

(54) Methods of treating alzheimer's disease and pharmaceutical compositions thereof.

(72) SCHMIDT, Ellen;

AREBERG, Johan.

(73) H Lundbeck A/S (DK)

(74) Cabinet Spoor & Fisher Inc. Ngwafor & Partners, Blvd. du 20 Mai, Immeuble Centre Commercial de l'Hôtel Hilton, 2è Etage, Porte 208A, P.O. Box 8211, YAOUNDE (CM).

(57) The present invention describes methods of treating dementia comprising administering an effective daily dose of N-(2-(6-fluoro-1H-indol-3-yl)ethyl-(2,2,3,3-tetrafluoropropoxy)benzylamine to improve or augment the effect of an acetylcholinesterase inhibitor.

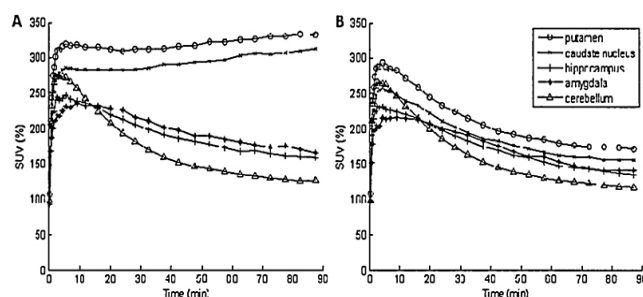

Figure 1

[Consulter le mémoire](#)

(11) **17282**(51) C10M 173/02; C09D 7/12; C09D 201/00
C10N 30/00; F16L 15/00; C10M 147/00
C09D 163/00; C09D 179/08

(21) 1201500077 - PCT/JP13/074356

(22) 10.09.2013

- (30) JP n° 2012-200118 du 12/09/2012
- (54) Composition for use in forming solid coating film, and tubular threaded joint.
- (72) GOTO, Kunio.
- (73) Nippon Steel & Sumitomo Metal Corporation (JP);
Vallourec Oil and Gas France (FR)
- (74) Cabinet Spoor & Fisher Inc. Ngwafor & Partners, Blvd. du 20 Mai, Immeuble Centre Commercial de l'Hôtel Hilton, 2è Etage, Porte 208A, P.O. Box 8211, YAOUNDE (CM).
- (57) A composition for solid coating formation, includes a composition made by containing, in a mixed solvent including water and a dipolar aprotic solvent, a powdery organic resin which is partially soluble at least in the dipolar aprotic solvent. The powdery organic resin is present in the state of being dissolved or dispersed in the mixed solvent.

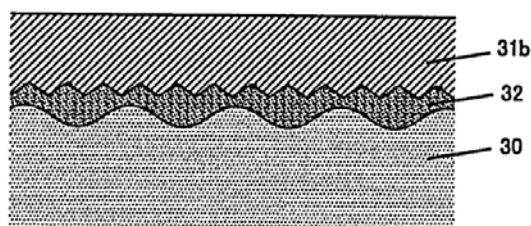
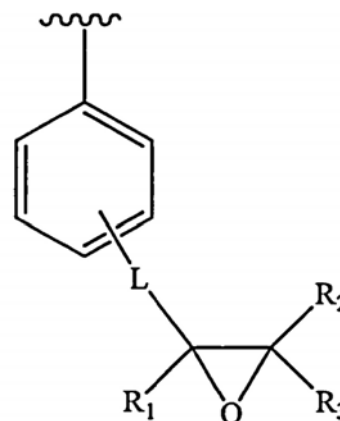

Fig. 3A

[Consulter le mémoire](#)

- (11) **17283**
- (51) C08F 2/18
- (21) 1201500095 - PCT/US13/063637
- (22) 07.10.2013
- (30) US n° 61/711, 767 du 10/10/2012
- (54) Water insoluble copolymer including pendant aryl epoxide groups.
- (72) SCHULTZ, Alfred K.;
CARDOEN, Gregoire;
HARRIS, William I.;
HARRIS, William J.;
MARSTON, Charles R.;
MOLL, David J.
- (73) Rohm and Haas Company (US);
Dow Global Technologies LLC (US)

- (74) Cabinet Spoor & Fisher Inc. Ngwafor & Partners, Blvd. du 20 Mai, Immeuble Centre Commercial de l'Hôtel Hilton, 2è Etage, Porte 208A, P.O. Box 8211, YAOUNDE (CM).
- (57) A water-insoluble copolymer including an epoxide containing structural unit represented by formula (I)



wherein : the epoxide containing group is positioned meta, ortho or para on the ring relative to the bond linkage with the polymer backbone; L is an optional linking group; and R₁, R₂ and R₃ are independently selected from : hydrogen, or a substituted or unsubstituted hydrocarbyl group.

[Consulter le mémoire](#)

- (11) **17284**
- (51) C12N 15/113; A61P 13/12; A61K 31/7125
- (21) 1201500104 - PCT/US13/063884
- (22) 08.10.2013
- (30) US n° 61/711,514 du 09/10/2012
US n° 61/779,137 du 13/03/2013
- (54) Methods for treatment of Alport syndrome.
- (72) DUFFIELD, Jeremy;
BHAT, Balkrishen;
MACKENNA, Deldre.
- (73) Regulus Therapeutics Inc. (US)
- (74) Cabinet Spoor & Fisher Inc. Ngwafor & Partners, Blvd. du 20 Mai, Immeuble Centre Commercial de l'Hôtel Hilton, 2è Etage, Porte 208A, P.O. Box 8211, YAOUNDE (CM).
- (57) Provided herein are methods for the treatment of Alport Syndrome, using modified oligonucleotides targeted to miR-21. In certain embodiments, a modified oligonucleotide targeted to miR-21 improves kidney function and/or

reduces fibrosis in subjects having Alport Syndrome. In certain embodiments, administration of a modified oligonucleotide targeted to miR-21 delays the onset of end-stage renal disease in a subject having Alport Syndrome. In certain embodiments, a modified oligonucleotide targeted to miR-21 delays the need for dialysis or kidney transplant in a subject having Alport Syndrome.

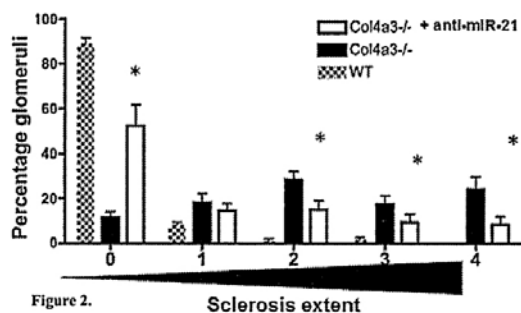

Figure 2.

[Consulter le mémoire](#)

(11) **17285**

(51) A61K 31/55; A61P 3/04

(21) 1201500122 - PCT/US12/063711

(22) 06.11.2012

(30) US n° 61/711,413 du 09/10/2012

(54) Method of weight management.

(72) SANCHEZ, Matilde;

SHANAHAN, William R.

(73) ARENA PHARMACEUTICALS, INC. (US)

(74) SCP AKKUM, AKKUM & Associates, Quartier Mballa II, Dragages, B.P. 4966, YAOUNDE (CM).

(57) Provided are methods of determining if an individual is a responder to treatment with (R)-8-chloro-1-methyl-2,3,4,5-tetrahydro-1H-3-benzazepine or a pharmaceutically acceptable salt, solvate or hydrate thereof. Also provided are methods for selecting an individual for treatment with (R)-8-chloro-1-methyl-2,3,4,5-tetrahydro-1H-3-benzazepine or a pharmaceutically acceptable salt, solvate or hydrate thereof from a plurality of individuals in need of weight management. Also provided are methods for weight management in an individual in need thereof. Also provided are

compounds, compositions, and kits for use in a method of weight management in an individual.

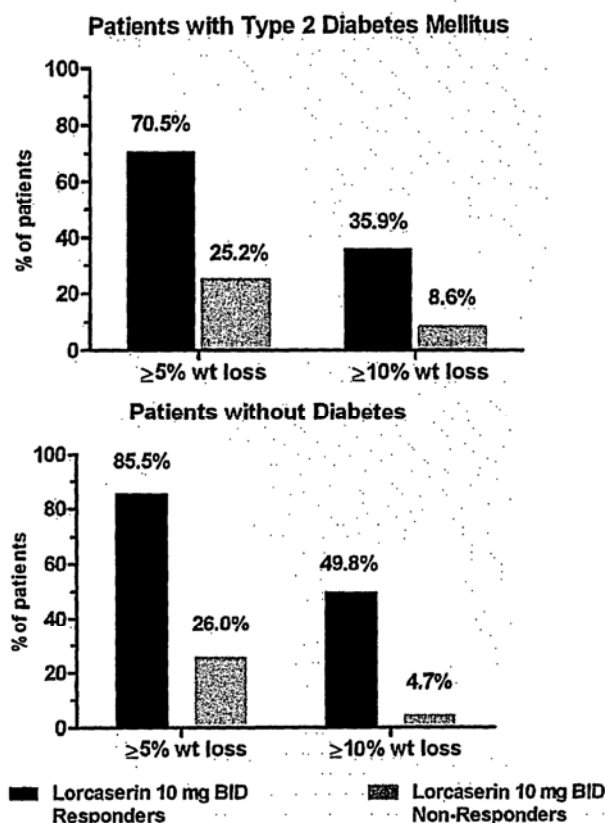

Fig. 1

[Consulter le mémoire](#)

(11) **17286**

(51) C07K 14/575; A61K 38/26; C07K 14/605

(21) 1201500124 - PCT/EP13/070882

(22) 08.10.2013

(30) EP n° 12306232.5 du 09/10/2012

EP n° 13305222.5 du 27/02/2013

(54) Exendin-4 derivatives as dual GLP1/glucagon agonists.

(72) HAACK Torsten;

WAGNER Michael;

HENKEL Bernd;

STENGELIN Siegfried;

EVERS Andreas;

BOSSART Martin.

(73) SANOFI (FR)

(74) Cabinet CAZENAVE SARL, B.P. 500, YAOUNDE (CM).

(57) The present invention relates to exendin-4 derivatives and their medical use, for example in the treatment of disorders of the metabolic syndrome, including diabetes and obesity, as well as reduction of excess food intake.

[Consulter le mémoire](#)

(11) **17287**

(51) C07D 405/12; C07D 307/80; C07D 413/12
A61K 31/343; C07D 417/12; A61P 3/10

(21) 1201500131 - PCT/EP13/074386

(22) 21.11.2013

(30) EP n° 12194590.1 du 28/11/2012

(54) New indanyloxydihydrobenzofuranylacetic acids.

(72) ECKHARDT Matthias;
LANGKOPF Elke;
WAGNER Holger.

(73) Boehringer Ingelheim International GmbH
(DE)

(74) Cabinet ÉKÉMÉ LYSAGHT SARL,
B.P. 6370, YAOUNDE (CM).

(57) Mif The present invention relates to compounds of general formula I

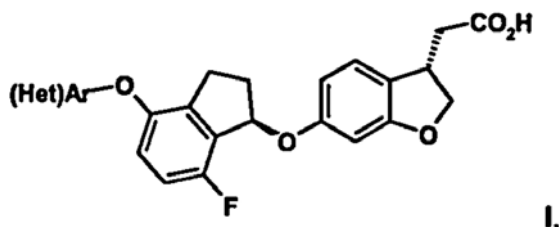

wherein the group (Het)Ar is defined as in claim 1, which have valuable pharmacological properties, in particular bind to the GPR40 receptor and modulate its activity. The compounds are suitable for treatment and prevention of diseases which can be influenced by this receptor, such as metabolic diseases, in particular diabetes type 2.

[Consulter le mémoire](#)

(11) **17288**

(51) C07D 415/04; C07D 471/04; C07D 491/04
A61K 31/51; A61P 3/00

(21) 1201500132 - PCT/IN13/000627

(22) 17.10.2013

(30) IN n° 3030/MUM/2012 du 17/10/2012

(54) 2-phenyl-5-heterocyclyl-tetrahydro-2H-pyran-3-amine compounds for use in the treatment of diabetes and its associated disorders.

(72) DESAI Ranjit C.;
BAHEKAR Rajesh;
JADAV Pradip;
GOSWAMI Amitgiri;
PATEL Pankaj.

(73) Cadila Healthcare Limited (IN)

(74) Cabinet ÉKÉMÉ LYSAGHT SARL,
B.P. 6370, YAOUNDE (CM).

(57) The present invention relates to novel compounds of the general formula (I)

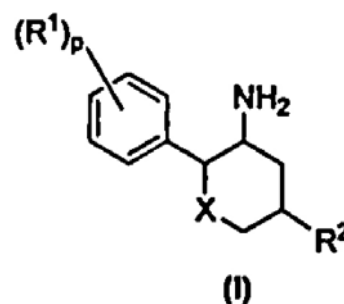

their tautomeric forms, their enantiomers, their diastereoisomers, their pharmaceutically accepted salts, or pro-drugs thereof, which are useful for the treatment or prevention of diabetes mellitus (DM), obesity and other metabolic disorders. The invention also relates to process for the manufacture of said compounds, and pharmaceutical compositions containing them and their use.

[Consulter le mémoire](#)

(11) **17289**

(51) A01N 43/48

(21) 1201500139 - PCT/US13/066349

(22) 23.10.2013

(30) US n° 61/718,026 du 24/10/2012

US n° 61/736,179 du 12/12/2012

(54) Stable preservative-free mydriatic and anti-inflammatory solutions for injection.

(72) DEMOPULOS, Gregory, A.;
SHEN, Hui-Rong;
TEDFORD, Clark, E.

(73) OMEROS CORPORATION (US)

(74) SCP AKKUM, AKKUM & Associates,
Quartier Mballa II, Dragages, B.P. 4966,
YAOUNDE (CM).

(57) The present invention relates to stable,
preservative- and antioxidant-free liquid
formulations of phenylephrine and ketorolac for
injection.

[Consulter le mémoire](#)

(11) **17290**

(51) C001N 33/574

(21) 1201500150 - PCTEP13/072459

(22) 25.10.2013

(30) EP n° PCT/EP2012/071163 du 25/10/2012

(54) Methylglyoxal as marker of cancer.

(72) BELPOMME Dominique;

IRIGARAY Philippe.

(73) ASSOCIATION POUR LA RECHERCHE
THERAPEUTIQUE ANTI-CANCEREUSE (FR)

(74) Cabinet CAZENAVE SARL, B.P. 500,
YAOUNDE (CM).

(57) The invention relates to a reliable, sensitive
and easy to handle diagnostic and prognostic test
of cancer, by measuring and analyzing the
production of methylglyoxal (MG) from
metabolically active cancer cells; in biological
samples of extracellular fluids, cells and/or tissues
of human or animal subjects. It uses any chemical
or immunological in vitro method for MG
measurement and it provides a kit for the early
detection, screening and diagnosis of cancer; for
the staging of cancer, for predicting the survival
odds of cancer patients, for monitoring therapeutic
response to anticancer programs (including
prevention and prophylactic treatments), and for
prediction and early detection of cachexia.

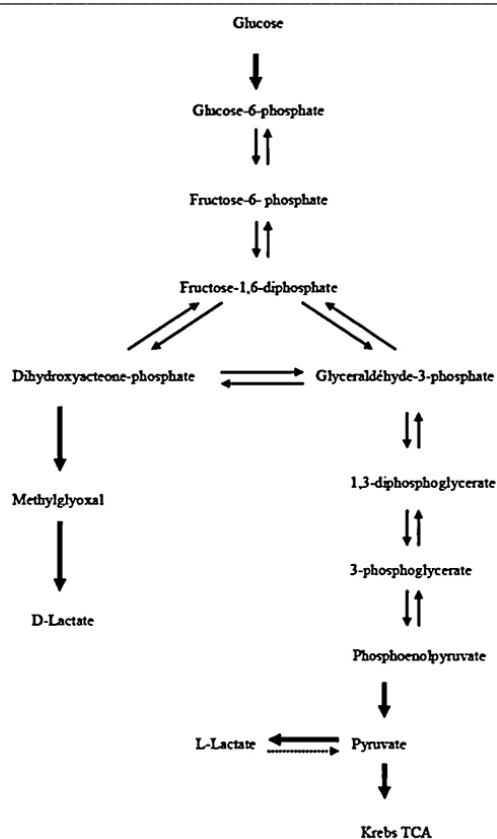

Fig. 1

[Consulter le mémoire](#)

(11) **17291**

(51) C07D 401/04; A61K 31/4155; A61K 31/454
A61P 55/00; A61P 35/00

(21) 1201500155 - PCT/IB13/059846

(22) 01.11.2013

(30) US n° 61/721,920 du 02/11/2012
US n° 61/772,028 du 04/03/2013

(54) Bruton's tyrosine kinase inhibitors.

(72) SPRINGER, John Robert;
DEVADAS, Balekudru;
GARLAND, Danny James;
GRAPPERHAUS, Margaret Lanahan;
HAN, Seungil;
HOCKERMAN, Susan Landis;
HUGHES, Robert Owen;
SAIAH, Eddine;
SCHNUTE, Mark Edward;
SELNESS, Shaun Raj;
WALKER, Daniel Patrick;
WAN, Zhao-Kui;
XING, Li;

ZAPF, Christoph Wolfgang;

SCHMIDT, Michelle, Ann.

(73) PFIZER INC. (US)

(74) SCP AKKUM, AKKUM & Associates, Quartier Mballa II, Dragages, B.P. 4966, YAOUNDE (CM).

(57) Disclosed herein are compounds that form covalent bonds with Bruton's tyrosine kinase (BTK). Methods for the preparation of the compounds are disclosed. Also disclosed are pharmaceutical compositions that include the compounds. Methods of using the BTK inhibitors are disclosed, alone or in combination with other therapeutic agents, for the treatment of autoimmune diseases or conditions, heteroimmune diseases or conditions, cancer, including lymphoma, and inflammatory diseases or conditions.

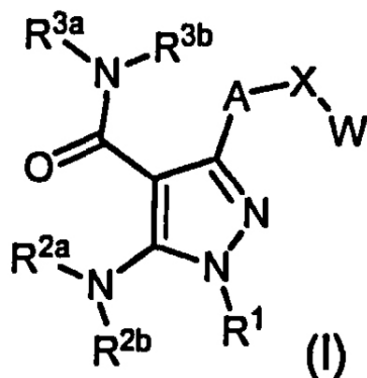

[Consulter le mémoire](#)

(11) **17292**

(51) A01C 15/00

(21) 1201400156

(22) 05.03.2014

(54) Compost à base de déchets alimentaires.

(72) DIENG Papa Mor.

(73) DIENG Papa Mor, Cité Castors Rue 13 x P - Villa n° 14 B.P. 10083 Sicap - Liberté, DAKAR (SN).

(57) L'invention concerne un compost obtenu à partir de matières premières constituées de déchets alimentaires provenant des repas distribués à l'occasion des cérémonies familiales, religieuses, ou provenant des restaurants et hôtels. Le compost est obtenu après une phase

préparatoire qui comprend 6 étapes, au bout duquel démarre la phase de maturation des matières premières stockées dans des bacs composteurs. Le compost obtenu est de couleur sombre, ayant une odeur de terre mouillée et une structure granuleuse.

[Consulter le mémoire](#)

(11) **17293**

(51) B03D 1/01

(21) 1201500157 - PCT/EP13/075196

(22) 02.12.2013

(30) US n° 61/731,622 du 30/11/2012

(54) Flotation of silicates from ores.

(72) DE LIMA, Odair Alves;

ALBINO, Kelly Ivone Pina.

(73) Akzo Nobel Chemicals International B.V. (NL)

(74) Cabinet Spoor & Fisher Inc. Ngwafor & Partners, Blvd. du 20 Mai, Immeuble Centre Commercial de l'Hôtel Hilton, 2è Etage, Porte 208A, P.O. Box 8211, YAOUNDE (CM).

(57) The present invention relates to a method for the flotation of silicates from ores in the presence of a collecting agent and an effective amount of a froth modifier/collecting booster comprising at least one of the compounds of general formula (I)

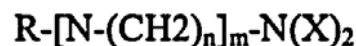

or mixtures thereof : wherein X is C₁-C₃ alkyl; R' is straight or branched hydrocarbonyl group containing 8 to 22 carbon atoms; n is integer from 2-4; m can vary from 0 to 2 and R' is X or -(CH₂)_n-N(X)₂, with the proviso that when R' is -(CH₂)_n-N(X)₂, then m is 1.

[Consulter le mémoire](#)

(11) **17294**

(51) AO1N 53/06; A61P 7/04

(21) 1201500158 - PCT/EP13/074383

(22) 21.11.2013

(30) EP n° 12194056.3 du 23/11/2012

(54) Use of a compound comprising a polyfluorobenzyl moiety against insecticide-resistant pests.

(72) HORSTMANN, Sebastian;

SONNECK, Rainer;

VELTEN, Robert;

WERNER, Stefan.

(73) Bayer CropScience AG (DE)

(74) Cabinet Spoor & Fisher Inc. Ngwafor & Partners, Blvd. du 20 Mai, Immeuble Centre Commercial de l'Hôtel Hilton, 2è Etage, Porte 208A, P.O. Box 8211, YAOUNDE (CM).

(57) The invention is in the technical field of insect control and relates to the use of a compound comprising a polyfluorobenzyl moiety for controlling insecticide-resistant pests such as mosquitoes and bed bugs.

[Consulter le mémoire](#)(11) **17295**

(51) A61K 38/46; A61P 25/28

(21) 1201500160 - PCT/US13/068242

(22) 04.11.2013

(30) US n° 61/722 434 du 05/11/2012

(54) Compositions and methods for treating proteinopathies.

(72) SARDI Sergio Pablo;

SHIHABUDDIN Lamya;

CHENG Seng.

(73) GENZYME CORPORATION (US)

(74) Cabinet CAZENAVE SARL, B.P. 500, YAOUNDE (CM).

(57) This disclosure relates to methods for improving neural function in a mammal with a proteinopathy comprising administering a therapeutically effective amount of an agent that

increases glucocerebrosidase activity in the mammal. Also disclosed are methods for reducing toxic lipids, reducing a-synuclein, and/or inhibiting the accumulation of protein aggregates in a mammal with a proteinopathy comprising administering a therapeutically effective amount of an agent that increases glucocerebrosidase activity.

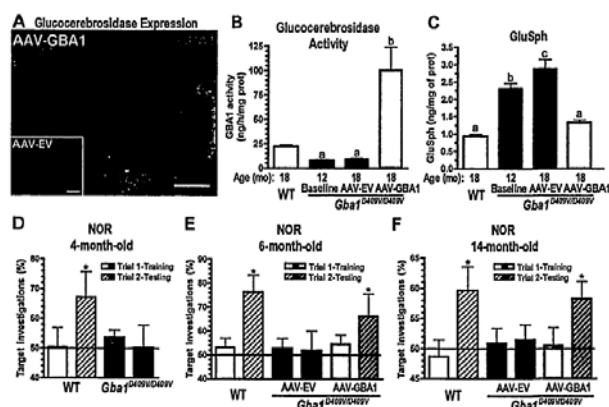

Fig. 2

[Consulter le mémoire](#)(11) **17296**(51) A62D 3/33; C01F 7/02; C02F 1/52
C22B 3/12

(21) 1201500161 - PCT/CA13/050792

(22) 21.10.2013

(30) AU n° 2012904908 du 07/11/2012

(54) Treatment of alkaline bauxite residue.

(72) ANDERSON John Victor;

ROUSSEAUX Jean-Marc;

PELOQUIN Guy;

O'BRIEN Ben.

(73) RIO TINTO ALCAN INTERNATIONAL LIMITED (CA)

(57) A process is disclosed for treating a Bayer process waste comprising a slurry containing bauxite residue and dissolved aluminium. The process comprises supplying the waste to a settling area to cause the bauxite residue to settle out of the slurry, thereby producing a supernatant liquor. The process further comprises neutralizing the supernatant liquor with a solution containing magnesium and calcium to produce a neutralized slurry containing precipitated hydrotalcites and thickening the neutralized slurry to produce a

clarified effluent and a compacted slurry containing the precipitated hydrotalcites, part of said compacted slurry being recirculated to the supernatant liquor to be neutralized and/or directly to the neutralizing step. The clarified effluent and the compacted slurry are disposed of separately. Also disclosed is a plant for treating a Bayer process waste.

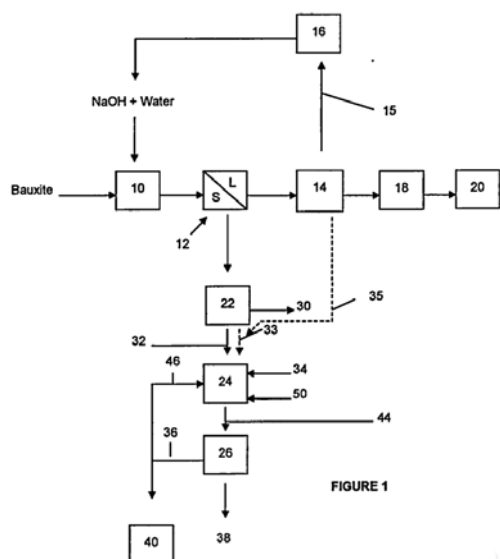

FIGURE 1

[Consulter le mémoire](#)

(11) **17297**

(51) A01N 57/26

(21) 1201500162 - PCT/US13/062629

(22) 30.09.2013

(30) US n° 13/718246 du 18/12/2012

(54) Method for treating sepsis in patients with albumin, cholesterol and HDL levels above minimum thresholds.

(72) LEVINE Daniel M;
PARKER Thomas S.;
GORDON Bruce R.;
SAAL Stuart D.

(73) Sepsicure LLC (US)

(74) Cabinet ÉKÉMÉ LYSAGHT SARL,
B.P. 6370, YAOUNDE (CM).

(57) The invention relates to a method for treating sepsis in subjects who exhibit serum albumin levels, and one of total cholesterol or HDL levels, above minimum threshold values. The method involves intravenous administration of an

emulsion, which contains a phospholipid, a neutral lipid, and a cholate salt.

[Consulter le mémoire](#)

(11) **17298**

(51) C07D 47/04; A61K 31/437

(21) 1201500163 - PCT/IB13/059768

(22) 30.10.2013

(30) US n° 61/723,995 du 08/11/2012

(54) Heteroaromatic compounds as dopamine D1 ligands.

(72) DAVOREN, Jennifer E.;
DOUNAY, Amy Beth;
EFREMOV, Ivan V.;
GRAY, David L. F.;
MENTE, Scot R.;
O'NEIL, Steven V.;
ROGERS, Bruce N.;
SUBRAMANYAM, Chakrapani;
ZHANG, Lei.

(73) PFIZER INC. (US)

(74) SCP AKKUM, AKKUM & Associates,
Quartier Mballa II, Dragages, B.P. 4966,
YAOUNDE (CM).

(57) The present invention provides, in part, compounds of formula I :

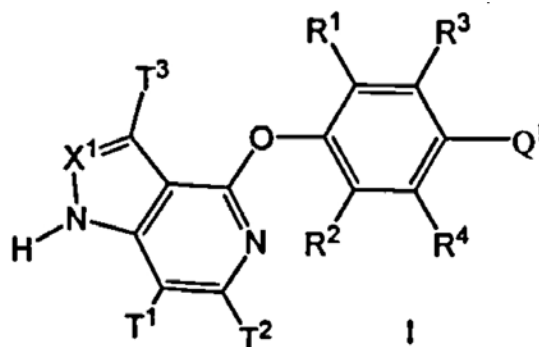

and pharmaceutically acceptable salts thereof and N-oxides of the foregoing; processes for the preparation of; intermediates used in the preparation of; and compositions containing such compounds, salts or N-oxides, and their uses for treating D1-mediated (or D1-associated) disorders including, e.g., schizophrenia (e.g., its cognitive and negative symptoms), cognitive impairment (e.g., cognitive impairment associated with schizophrenia, AD, PD, or pharmacotherapy

therapy), ADHD, impulsivity, compulsive gambling, overeating, autism spectrum disorder, MCI, age-related cognitive decline, dementia, RLS, Parkinson's disease, Huntington's chorea, anxiety, depression, MDD, TRD, and bipolar disorder.

[Consulter le mémoire](#)

(11) **17299**

(51) D21H 21/40; D21H 17/33; B32B 27/10

(21) 1201500164 - PCT/RU13/000930

(22) 21.10.2013

(30) RU n° 2012147218 du 07/11/2012

(54) Counterfeit-proof multi-layered product and method for producing same.

(72) PAVLOV Igor Vasilievich;
RYBIN Konstantin Gennadievich;
TRACHUK Arkadiy Vladimirovich;
KURYATNIKOV Andrey Borisovich;
KORNILOV Georgiy Valentinovich;
FEDOROVA Elena Mikhailovna;
TURKINA Elena Samuilovna;
CHEKUNIN Dmitry Borisovich;
TSVETKOV Vyacheslav Efimovich.

(73) Federalnoe Gosudarstvennoe Unitarnoe Predpriyatie "Goznak" (FGUP "GOZNAK") (RU)

(74) Cabinet ÉKÉMÉ LYSAGHT SARL, B.P. 6370, YAOUNDE (CM).

(57) The invention relates to paper technology, counterfeit-proof products, such as identification documents, bank cards, tokens serving as substitutes for banknotes. The technical result is in production of the substitutes for banknotes based on layered plastics containing security elements and exhibiting high resistance to aggressive attack and mechanical wear during use, and reducing the production cost thereof. A counterfeit-proof multilayer product comprises paper sheets with security elements, said sheets being impregnated with a polymer binder, and also outer polymer layers. The paper sheets are impregnated throughout the bulk with a melt of a thermosetting or thermoplastic polymer, and surfaces of each sheet are coated with a polymer layer. A method for producing a multilayer product includes impregnating paper sheets having

security elements with a melt of a thermosetting or thermoplastic polymer, or mixtures thereof, drying with partial polymerization, assembling a stack of the impregnated sheets, hot press laminating the stack while simultaneously forming a surface relief, and cutting out products of a predetermined geometric shape.

[Consulter le mémoire](#)

(11) **17300**

(51) A01M 1/00; A01M 1/20; A01M1 /02

(21) 1201500167 - PCT/IL13/050920

(22) 07.11.2013

(30) US n° 61/724,323 du 09/11/2012

US n° 13/792,266 du 11/03/2013

(54) Devices and methods for a durable insect bait station.

(72) HALAHMI Izhar

(73) WESTHAM LTD. (IL)

(74) GAD CONSULTANTS SCP, P.O. Box 13448, YAOUNDE (CM).

(57) The present invention discloses devices and methods for a durable insect bait station. Such devices including a membrane for providing access to the bait station, the membrane adapted to be permeable to volatile components, the membrane configured to allow easy insect-probe penetration, and to be resistant to degradation caused by outdoor environmental conditions and/or harsh indoor environmental conditions. Preferably, the membrane has at least one inclusion. Preferably, the membrane has at least one perforation. Preferably, the device further includes a bait core for providing bait to the bait station, the bait core including a sugar-source bait, at least one oral and/or contact insect toxin, and a solvent, wherein the bait core is configured to be substantially in direct contact with the membrane. Most preferably, the bait core further includes an odorant. Most preferably, the bait core further includes a fibrous material as a support for the membrane.

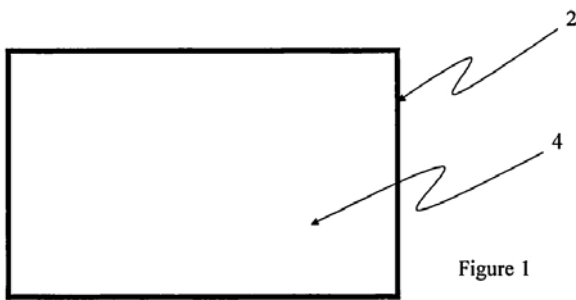

Figure 1

[Consulter le mémoire](#)

(11) **17301**

(51) A61M 5/32; A61M 5/315; A61M 5/20

(21) 1201500172 - PCT/IB13/003057

(22) 11.11.2013

(30) US n° 61/724,392 du 09/11/2012

US n° 61/830,895 du 04/06/2013

(54) Fluid delivery device and method.

(72) REISENBURG MOLSON, Catherine;

MOLSON, Alexandra;

GANEM, Jake.

(73) IINJEC TECHNOLOGIES INC. (CA)

(74) Cabinet Spoor & Fisher Inc. Ngwafor & Partners, Blvd. du 20 Mai, Immeuble Centre Commercial de l'Hôtel Hilton, 2è Etage, Porte 208A, P.O. Box 8211, YAOUNDE (CM).

(57) A fluid delivery injector comprises a syringe defining a barrel; a plunger and a hollow needle provided within the barrel adapted for linear movement parallel to a longitudinal axis with a distal tip of the needle contained within the syringe. A fluid retention reservoir is defined at least in the barrel and is in fluid communication with the needle when pressure is applied to the fluid in the reservoir and to the plunger for moving the needle out of the barrel. A spring may be provided for retracting the needle when pressure is released from the plunger.

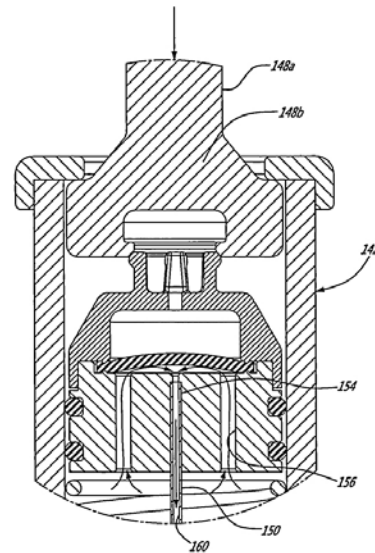

FIG. 6C

[Consulter le mémoire](#)

(11) **17302**

(51) C07K 16/08

(21) 1201500177

(22) 12.05.2015

(54) Molécule ayant la propriété de léser l'ADN du seul noyau de tous les micro-organismes asexués.

(72) Docteur WANDJI Thomas.

(73) Docteur WANDJI Thomas, B.P. 4741, YAOUNDE (CM).

(57) L'invention concerne la mise en évidence de la propriété d'une molécule d'origine végétale dénommée méthoxy-4-phenyl-1,2-méthyl-2-isothiocyanate de propyle, soluble dans l'éther de pétrole et de couleur jaune citron, qui lèse L'ADN de l'unique noyau des micro-organismes asexués entraînant la mort de ces derniers.

[Consulter le mémoire](#)

(11) **17303**

(51) A23N 12/10

(21) 1201500178 - PCT/EP13/073884

(22) 14.11.2013

(30) EP n° 12192655.4 du 14/11/2012

(54) Apparatus for drying and/or roasting beans or nibs.

- (72) KOELEMIEIJER, Reiner
- (73) ROYAL DUYVIS WIENER B.V. (NL)
- (74) SCP AKKUM, AKKUM & Associates, Quartier Mballa II, Dragages, B.P. 4966, YAOUNDE (CM).
- (57) The invention relates to an apparatus (1) for drying and/or roasting beans, such as cocoa beans, or parts of beans, such as nibs, comprising a frame (2), a drum (3) for receiving the (parts of) beans, rotatably mounted in the frame (2) and provided with an inlet (8) for a fluid, in particular a gas, such as heated air, a fan (14) for feeding the fluid via the inlet (8) to the drum (3), and a driving means (12) for rotating the drum (3). The fluid inlet (8) and the driving means (12) are located on the same end of the drum (3).

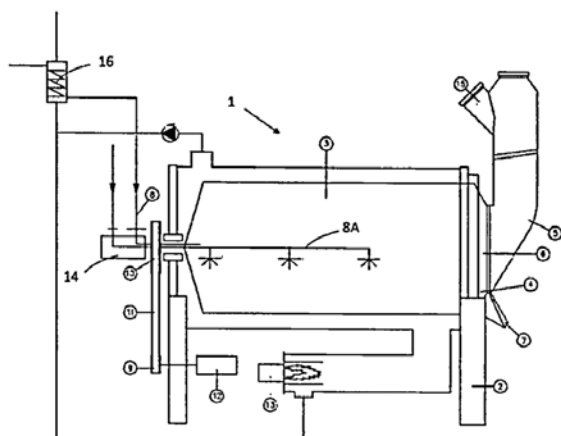

Fig. 1

[Consulter le mémoire](#)

- (11) **17304**
- (51) A61K 9/00; A61K 31/192
- (21) 1201500179 - PCT/EP13/073868
- (22) 14.11.2013
- (30) FR n° 1260815 du 14/11/2012
- (54) Pastille médicamenteuse à base d'ibuprofène sodique dihydraté.
- (72) CORDOLIANI Jean-François;
HARAMBILLET Nadine.
- (73) PIERRE FABRE MEDICAMENT (FR)

- (74) Cabinet CAZENAVE SARL, B.P. 500, YAOUNDE (CM).
- (57) La présente invention a pour objet des pastilles médicamenteuses à sucer, de consistance solide pour se dissoudre dans la cavité buccale comprenant au moins l'ibuprofène sodique dihydraté comme principe actif, destinées au traitement des affections bucco-pharyngées.

[Consulter le mémoire](#)

- (11) **17305**
- (51) A61K 39/395; A61P 35/00; C07K 16/30
- (21) 1201500183 - PCT/EP13/074291
- (22) 20.11.2013
- (30) EP n° 12306444.6 du 20/11/2012
- (54) Anti-CEACAM5 antibodies and uses thereof.
- (72) BERNE Pierre-François;
BLANCHE Francis;
BOUCHARD Hervé;
CAMERON Béatrice;
DABDOUBI Tarik;
DECARY Stéphanie;
FERRARI Paul;
RAK Alexey.
- (73) SANOFI (FR)
- (74) Cabinet CAZENAVE SARL, B.P. 500, YAOUNDE (CM).
- (57) The present disclosure discloses antibodies which bind human and *Macaca fascicularis* CEACAM5 proteins, as well as isolated nucleic acids, vectors and host cells comprising a sequence encoding said antibodies. The disclosure also discloses immunoconjugates comprising said antibodies conjugated or linked to a growth-inhibitory agent, and to pharmaceutical compositions comprising antibodies, or immunoconjugates of the disclosure. The

antibodies or immunoconjugates of the disclosure are used for the treatment of cancer or for diagnostic purposes.

[Consulter le mémoire](#)

(11) **17306**

(51) A61K 31/495; A61P 25/18

(21) 1201500185 - PCT/IB13/060465

(22) 28.11.2013

(30) HU n° P1200691 du 29/11/2012

(54) Trans-4-{2-[4-(2,3-dichlorophenyl)-piperazin-1-yl]-ethyl}-N,N-dimethylcarbamoyl-cyclohexylamine for treating negative symptoms of schizophrenia.

(72) PITTER Janos György;

SZATMARI Balázs;

NÉMETH György Jozsef;

DEBELLE Marc;

LASZLOVSZKY István.

(73) RICHTER GEDEON NYRT. (HU)

(74) Cabinet CAZENAVE SARL, B.P. 500, YAOUNDE (CM).

(57) The present invention relates to trans-4-{2-[4-(2,3-dichlorophenyl)-piperazin-1-yl]-ethyl} -N,N-dimethylcarbamoyl-cyclohexylamine (cariprazine) and pharmaceutical acceptable salts and hydrates and solvates and polymorphs thereof for use in the treatment of primary negative symptoms of schizophrenia and/or predominantly negative symptoms of schizophrenia.

[Consulter le mémoire](#)

(11) **17307**

(51) A61P 15/00

(21) 1201500188

(22) 11.05.2015

(54) Crème pour le traitement des pieds d'athlètes et son procédé d'obtention.

(72) M. ATTA Kouassi Isac

(73) M. ATTA Kouassi Isac, 06 B.P. 2889, ABIDJAN 06 (CI).

(57) L'invention concerne une crème pour le traitement des dermatomycoses du genre tinea pedis ou pieds d'athlètes. L'invention est une crème constituée de 0,5 à 1 kg de glycérine, 100 à 800 g de chlobetazole dipropionate, la décoction d'aloès et du MPG, du chlore actif, et des cristaux de sel marin. D'abord, on procède à l'ajout du chlobetazole à de la glycérine dans un même récipient. On mélange la solution obtenue. Ensuite, on adjoint la décoction d'aloès et le MPG puis nouvelle agitation. Enfin, de façon successive, on ajoute le chlore actif suivi des cristaux de sel marin et on homogénéise.

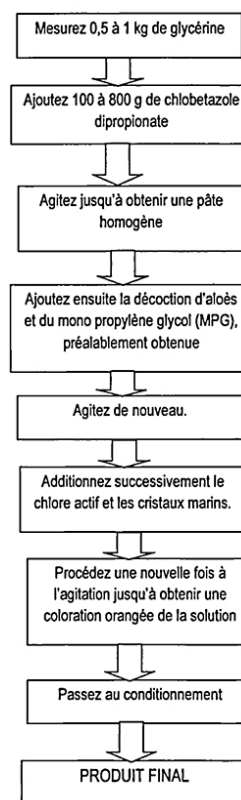

[Consulter le mémoire](#)

(11) **17308**

(51) A61P 25/00

(21) 1201500191

(22) 11.05.2015

(54) Substance naturelle pour guérir l'autisme et la déficience intellectuelle.

(72) M.CISSE Abdoulaye

(73) M.CISSE Abdoulaye, B.P. 06, BONGOU-ANOU (CI).

(57) L'invention est une substance naturelle obtenue à partir du mélange du jus d'orange, de l'eau de coco et du miel pour guérir l'autisme et la déficience intellectuelle ou retard mental. Cette substance est très riche en iode ainsi qu'en d'autres éléments comme le potassium, le phosphore, le soufre et les vitamines B2, E et C. En outre, elle permet d'éliminer les troubles du sommeil, d'améliorer le quotient intellectuel et de corriger le retard dans le langage et dans le comportement dus à l'autisme et à la déficience intellectuelle. Mieux, elle permet de guérir l'autisme et la déficience intellectuelle en stimulant l'hypothalamus et l'hypophyse indispensables pour la sécrétion de plusieurs hormones comme la thyroxine.

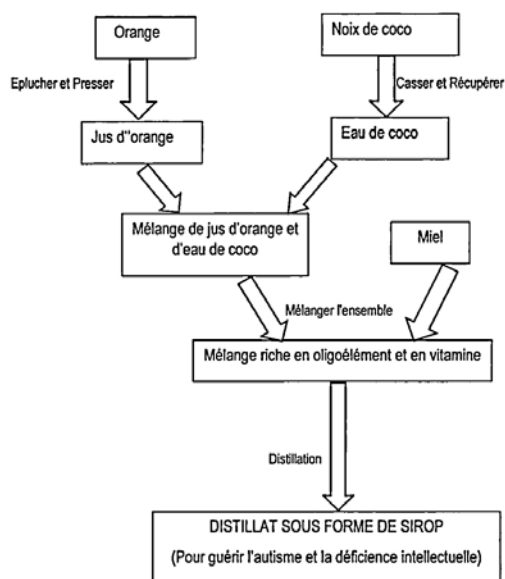

[Consulter le mémoire](#)

(11) **17309**

(51) A6IK 31/232; A61P 7/00; A61K 31/4406

(21) 1201500202 - PCT/EP13/074863

(22) 27.11.2013

(30) FR n° 1261291 du 27/11/2012

(54) Utilisation d'un ester de DHA pour le traitement prophylactique et/ou curatif de la drépanocytose.

(72) CAUBERE Jean-Paul;

LANTOINE-ADAM Frédérique.

(73) PIERRE FABRE MEDICAMENT (FR)

(74) Cabinet CAZENAVE SARL, B.P. 500, YAOUNDE (CM).

(57) La présente invention a pour objet un ester de l'acide docosahexaénoïque avec un alcool choisi parmi le groupe constitué par le nicotinol, le panthénol, l'inositol, l'isosorbide et l'isosorbide mononitrate, ou l'un de ses sels pharmaceutiquement acceptables, énantiomères, diastéréoisomères, ou leur mélange, y compris les mélanges racémiques, pour son utilisation à titre de médicament pour le traitement prophylactique et/ou curatif de la drépanocytose.

[Consulter le mémoire](#)

(11) **17310**

(51) C07D 217/26; C07C 255/58; A61K 31/4725
A61P 5/26; A61P 21/00; A61P 19/00
A61P 25/00; A61P 3/00

(21) 1201500203 - PCT/IB13/060381

(22) 25.11.2013

(30) US n° 61/732,617 du 03/12/2012

(54) Novel selective androgen receptor modulators.

(72) ANDERSON, James, Thomas;

CHEKLER Eugene, Lvovich, Piatnitski;

ELLSWORTH, Edmund, L.;

ERICKSON, Bruce, Kipp;

GILBERT, Adam, Matthew;

RICKETTS, Anthony, P.;

THOMPSON, David, P.;

UNWALLA, Rayomand, Jal;

VERHOEST, Patrick, Robert.

(73) PFIZER INC. (US)

(74) SCP AKKUM, AKKUM & Associates,
Quartier Mballa II, Dragages, B.P. 4966,
YAOUNDE (CM).

(57) Formula (I), formula (II) and formula (III)

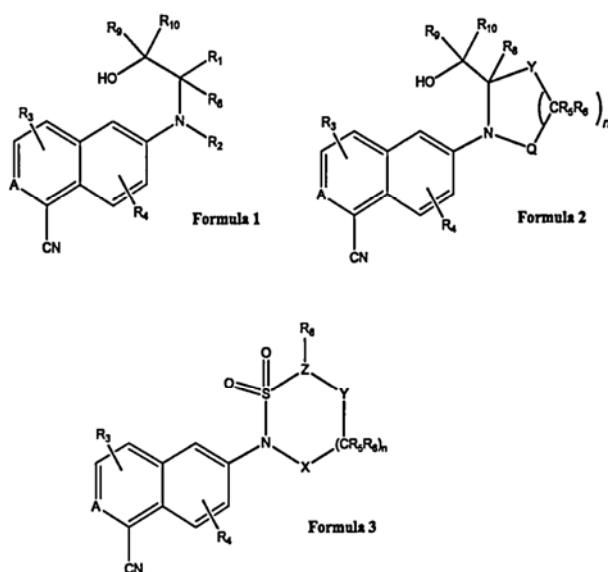

The present invention relates to a compound of formula 1, 2 or 3 : wherein A is N or -CR0 --, where R0 is hydrogen, C₁-C₆ linear or branched chain alkyl, etc., Z is -CRe --, or, -N-, where Re is hydrogen, C₁-C₆ linear or branched chain alkyl, etc.; R₁ is hydrogen, C₁-C₆ linear or branched chain alkyl, etc.; R₂ are independently hydrogen or C₁-C₆ linear or branched chain alkyl; R₃ and R₄ are independently hydrogen, C₁-C₆ linear or branched chain alkyl, etc.; R₅ and R₆ are independently hydrogen or C₁-C₆ linear or branched chain alkyl, etc.; R₈ is hydrogen, C₁-C₆ linear or branched chain alkyl, etc.; R₉ and R₁₀ are independently hydrogen or C₁-C₆ linear or branched chain alkyl, etc.; Q is -CO--, --(CH₂)_q - (CHR_s)_q --, or -(CR_sR_t)_q --, where R_s and R_t are independently C₁-C₆ linear or branched chain alkyl, aryl, alkylaryl, heteroaryl or alkylheteroaryl; where q is 0, 1, 2, or 3; and, where n is 0, 2, 3, 4 or 5; or, a pharmaceutically acceptable salt thereof, to compositions containing such compounds; and to the uses of such compounds in the treatment of various diseases, particularly, those affected or mediated by the androgen receptor.

[Consulter le mémoire](#)

(11) **17311**

(51) C07C 235/40; C07C 237/14; C07D 307/00

(21) 1201500205 - PCT/EP13/075481

(22) 04.12.2013

(30) FR n° 1261621 du 04/12/2012

(54) Dérivés d'aminocyclobutane, leur procédé de préparation et leur utilisation à titre de médicaments.

(72) VACHER Bernard;

DEPOORTERE Ronan ;

BLANC Elodie.

(73) PIERRE FABRE MEDICAMENT (FR)

(74) Cabinet CAZENAVE SARL, B.P. 500,
YAOUNDE (CM).

(57) La présente invention a pour objet des dérivés d'aminocyclobutane, notamment en tant qu'antagonistes des récepteurs NMDA, leur application en thérapeutique humaine et leur procédé de préparation. Ces composés correspondent à la formule générale (1)

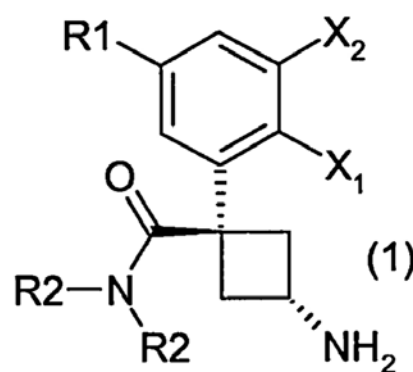

pour laquelle : X₁ représente un atome d'hydrogène ou un atome de fluor; X₂ est un atome d'hydrogène ou un atome de fluor ou un atome de chlore; R₁ représente un atome d'hydrogène ou un atome de fluor ou un atome de chlore ou un groupe méthyle ou un groupe méthoxy ou un groupe cyano; R₂ représente ensemble ou séparément un groupe méthyle ou un groupe éthyle.

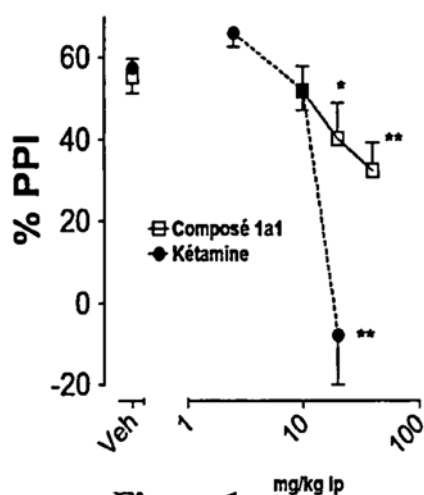

Figure 1

[Consulter le mémoire](#)

(11) **17312**

(51) C10L 1/02; D21C 3/20

(21) 1201500207

(22) 12.05.2015

(54) Procédé d'obtention industriel de bio carburant à base d'huile de palme.

(72) KANDJI Astou

(73) KANDJI Astou, Cité Hacienda - Hann, Daliford, DAKAR (SN).

(57) La présente invention concerne un procédé de fabrication de bio carburant à base d'huile de palme. Le procédé comprend 8 phases que sont : le découpage des régimes bien murs du palmier, la fermentation, l'égrenage des noix, la cuisson des fruits, le broyage, la cuisson, la filtration, la mise en bouteille.

[Consulter le mémoire](#)

(11) **17313**

(51) C07D 401/06; C07D 413/14; C07D 403/14
C07D 407/14; C07D 471/14

(21) 1201500206 - PCT/IB13/060682

(22) 05.12.2013

(30) US n° 61/740,596 du 21/12/2012

(54) Aryl and heteroaryl fused lactams.

(72) EDWARDS, Martin Paul;

KUMPF, Robert Arnold;

KUNG, Pei-Pei;

MCALPINE, Indrawan James;

NINKOVIC, Sacha;

RUI, Eugene Yuanjin;

SUTTON, Scott Channing;

TATLOCK, John Howard;

WYTHES, Martin James;

ZEHNDER, Luke Raymond.

(73) PFIZER INC. (US)

(74) SCP AKKUM, AKKUM & Associates, Quartier Mballa II, Dragages, B.P. 4966, YAOUNDE (CM).

(57) This invention relates to compounds of general formula (I),

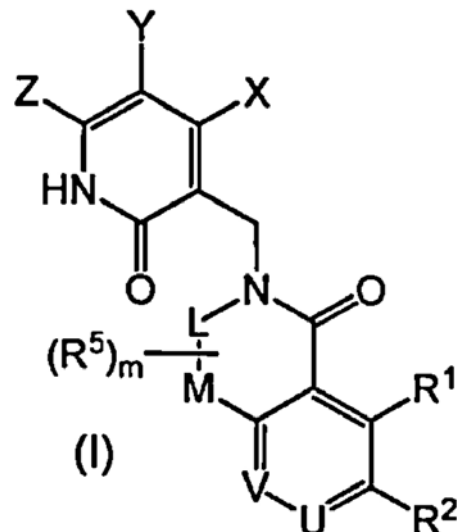

in which R^1 , R^2 , U, V, L, M, R^5 , m, X, Y and Z are as defined herein, and the pharmaceutically acceptable salts thereof, to pharmaceutical compositions comprising such compounds and salts, and to methods of using such compounds, salts and compositions for the treatment of abnormal cell growth, including cancer.

[Consulter le mémoire](#)

(11) **17314**(51) A61K 31/445; A61K 31/495; A61P 25/00
A61P 25/16; A61P 25/28

(21) 1201500209 - PCT/EP13/076337

(22) 12.12.2013

(30) US n° 61/736,799 du 13/12/2012

(54) Compositions comprising vortioxetine and donepezil.

(72) MORILLO, Connie, Sanchez

(73) H. Lundbeck A/S (DK)

(74) Cabinet Spoor & Fisher Inc. Ngwafor & Partners, Blvd. du 20 Mai, Immeuble Centre Commercial de l'Hôtel Hilton, 2è Etage, Porte 208A, P.O. Box 8211, YAOUNDE (CM).

(57) Pharmaceutical compositions comprising vortioxetine and donepezil are provided and the use of such composition for the treatment of cognitive dysfunctions.

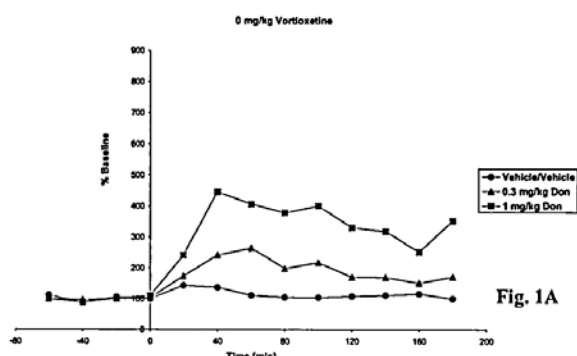

Fig. 1A

[Consulter le mémoire](#)(11) **17315**

(51) C02 F9/00; C02F 1/32

(21) 1201500217 - PCT/FR13/053016

(22) 10.12.2013

(30) FR n° 1261944 du 12/12/2012

(54) Procédé d'oxydation d'eaux de production.

(72) LESAGE Nicolas;

PEDENAUD Pierre;

JACOB Matthieu.

(73) Total S.A. (FR)

(74) Cabinet ÉKÉMÉ LYSAGHT SARL,
B.P. 6370, YAOUNDE (CM).

(57) L'invention a pour objet un procédé de dépollution d'une eau de production comprenant les étapes consistant à introduire ladite eau de production et de l'ozone dans un réacteur contenant des zéolithes, à soumettre l'eau de production dans le réacteur à une irradiation par une lumière UV, puis à séparer l'eau de production des zéolithes grâce à un moyen de séparation, pour obtenir une eau de production dépolluée. L'invention a également pour objet un dispositif de dépollution d'une eau de production.

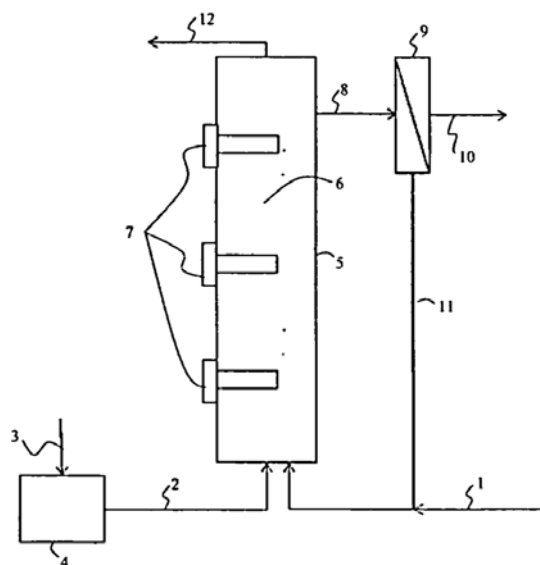

Fig. 1

[Consulter le mémoire](#)

B
REPERTOIRE SUIVANT LA C.I.B.

(51)	(11)
A01C 15/00	17292
A01M 1/00	17300
A01N 43/40	17275
A01N 43/40	17276
A01N 43/40	17277
A01N 43/40	17278
A01N 43/40	17280
A01N 43/48	17289
A01N 53/06	17294
A01N 57/26	17297
A01W 43/40	17279
A23N 12/10	17303
A61K 31/232	17309
A61K 31/445	17314
A61K 31/495	17306
A61K 31/55	17285
A61K 39/395	17305
A61K 38/46	17295
A61K 45/06	17281
A61K 9/00	17304
A61M 5/32	17301
A61P 15/00	17307
A61P 25/00	17308
A61P 27/02	17266
A61P 9/00	17267
A62D 3/33	17296
B03D 1/01	17293
C001N 33/574	17290
C02 F9/00	17315
C05F 7/00	17270
C07C 235/40	17311
C07D 217/26	17310
C07D 401/04	17291
C07D 401/06	17313
C07D 405/12	17287
C07D 415/04	17288
C07D 47/04	17298
C07K 14/575	17286

(51)	(11)
C07K 16/08	17302
C08F 2/18	17283
C10L 1/02	17312
C10M 173/02	17282
C12N 15/113	17284
C21D 1/38	17271
D21H 21/40	17299
E21B 17/10 (06.01)	17273
E21B 32/12 (06.01)	17274
F16L 15/04 (06.01)	17268
G06F 17/30 (06.01)	17269
G60Q 10/00 (06.01)	17272

C
REPERTOIRE DES NOMS

Ace Oil Tools AS (11) 17273 (51) E21B 17/10 (06.01)	IINJEC TECHNOLOGIES INC. (11) 17301 (51) A61M 5/32
Akzo Nobel Chemicals International B.V. (11) 17293 (51) B03D 1/01	KANDJI Astou (11) 17312 (51) C10L 1/02
ARENA PHARMACEUTICALS, INC. (11) 17285 (51) A61K 31/55	LONGEVITY ENGINEERING SA (11) 17271 (51) C21D 1/38
ASSOCIATION POUR LA RECHERCHE THERAPEUTIQUE ANTI-CANCEREUSE (11) 17291 (51) C001N 33/574	Nippon Steel & Sumitomo Metal Corporation and Vallourec Mannesmann Oil & Gas France (11) 17268 (51) F16L 15/04 (06.01)
ATTA Kouassi Isac (Monsieur) (11) 17307 (51) A61P 15/00	Nippon Steel & Sumitomo Metal Corporation and Vallourec Oil and Gas France (11) 17282 (51) C10M 173/02
Bayer CropScience AG (11) 17294 (51) A01N 53/06	OMEROS CORPORATION (11) 17289 (51) A01N 43/48
Boehringer Ingelheim International GmbH (11) 17287 (51) C07D 405/12	PFIZER INC. (11) 17291 (51) C07D 401/04 (11) 17298 (51) C07D 47/04 (11) 17310 (51) C07D 217/26 (11) 17313 (51) C07D 401/06
Cadila Healthcare Limited (11) 17288 (51) C07D 415/04	PIERRE FABRE MEDICAMENT (11) 17304 (51) A61K 9/00 (11) 17309 (51) A61K 31/232 (11) 17311 (51) C07C 235/40
CISSE Abdoulaye (Monsieur) (11) 17308 (51) A61P 25/00	Regulus Therapeutics Inc. (11) 17284 (51) C12N 15/113
DIENG Papa Mor (11) 17292 (51) A01C 15/00	RICHTER GEDEON NYRT. (11) 17306 (51) A61K 31/495
Docteur WANDJI Thomas (11) 17302 (51) C07K 16/08	RIO TINTO ALCAN INTERNATIONAL LIMITED (11) 17296 (51) A62D 3/33
Dow AgroSciencs LLC (11) 17278 (51) A01N 43/40	Rohm and Haas Company and Dow Global Technologies LLC (11) 17283 (51) C08F 2/18
Dow AgroSciences LLC (11) 17275 (51) A01N 43/40 (11) 17276 (51) A01N 43/40 (11) 17277 (51) A01N 43/40 (11) 17279 (51) A01W 43/40 (11) 17280 (51) A01N 43/40	ROYAL DUYVIS WIENER B.V. (11) 17303 (51) A23N 12/10
Federalnoe Gosudarstvennoe Unitarnoe Predpriyatie "Goznak" (FGUP "GOZNAK") (11) 17299 (51) D21H 21/40	SANOFI (11) 17286 (51) C07K 14/575 (11) 17305 (51) A61K 39/395
GENZYME CORPORATION (11) 17295 (51) A61K 38/46	Sepsicure LLC (11) 17297 (51) A01N 57/26
H Lundbeck A/S (11) 17281 (51) A61K 45/06	
H. Lundbeck A/S (11) 17314 (51) A61K 31/445	

STARSE Energy and Technology (Group) Co., Ltd and YI, Huian
(11) 17274 (51) E21B 32/12 (06.01)
Swiss Reinsurance Company Ltd.
(11) 17272 (51) G60Q 10/00 (06.01)
TCHIKA-MITTORI Gilbert
(11) 17266 (51) A61P 27/02
Tencent Technology (Shenzhen) Company Limited
(11) 17269 (51) G06F 17/30 (06.01)
Total S.A.
(11) 17315 (51) C02 F9/00
Unity Fertilizer LLC
(11) 17270 (51) C05F 7/00
WESTHAM LTD.
(11) 17300 (51) A01M 1/00
YESSOUFOU ADIDJATOU
(11) 17267 (51) A61P 9/00