

# Bulletin Officiel de la Propriété Industrielle (BOPI)

## Dessins et modèles industriels

PUBLICATION

N° 01 DM / 2015

du 14 Decembre 2015

Organisation  
Africaine de la  
Propriété  
Intellectuelle



**SOMMAIRE**

<b>TITRE</b>	<b>PAGES</b>
<b>PREMIERE PARTIE : GENERALITES</b>	<b>2</b>
Extrait de la norme ST3 de l'OMPI utilisée pour la représentation des pays et organisations internationales	<b>3</b>
Extrait de la norme ST. 80 de l'OMPI utilisée en matière de documentation de Dessins et Modèles Industriels	<b>6</b>
Codes utilisés en matière de Dessins et Modèles Industriels Renouvelés	<b>6</b>
Classification Internationale des Dessins et Modèles Industriels en vertu de l'Arrangement de LOCARNO du 08 Octobre 1968 (9 <sup>e</sup> édition)	<b>7</b>
Clarification du Règlement relatif à l'Extension des Droits suite à une nouvelle Adhésion à l'Accord de Bangui	<b>9</b>
Adresses utiles	<b>10</b>
<b>DEUXIEME PARTIE : DESSINS ET MODELES INDUSTRIELS</b>	<b>11</b>
Dessins et Modèles Industriels du N° 04461 au N° 04480	<b>12</b>

**PREMIERE PARTIE  
GENERALITES**

## Extrait de la norme ST.3 de l'OMPI

Code normalisé à deux lettres recommandé pour la représentation des pays ainsi que d'autres entités et des organisations internationales délivrant ou enregistrant des titres de propriété industrielle.

Afghanistan	<b>AF</b>	Cook, Îles	<b>CK</b>
Afrique du Sud	<b>ZA</b>	Corée (République de Corée)	<b>KR</b>
Albanie	<b>AL</b>	Corée (Rép. Populaire de Corée)	<b>KP</b>
Algérie	<b>DZ</b>	Costa Rica	<b>CR</b>
Allemagne	<b>DE</b>	Côte d'Ivoire*	<b>CI</b>
Andorre	<b>AD</b>	Croatie	<b>HR</b>
Angola	<b>AO</b>	Cuba	<b>CU</b>
Anguilla	<b>AI</b>	Danemark	<b>DK</b>
Antigua-et-Barbuda	<b>AG</b>	Djibouti	<b>DJ</b>
Antilles Néerlandaises	<b>AN</b>	Dominicaine, République	<b>DO</b>
Arabie Saoudite	<b>SA</b>	Dominique	<b>DM</b>
Argentine	<b>AR</b>	Egypte	<b>EG</b>
Arménie	<b>AM</b>	El Salvador	<b>SV</b>
Aruba	<b>AW</b>	Emirats Arabes Unis	<b>AE</b>
Australie	<b>AU</b>	Equateur	<b>EC</b>
Autriche	<b>AT</b>	Erythrée	<b>ER</b>
Azerbaïdjan	<b>AZ</b>	Espagne	<b>ES</b>
Bahamas	<b>BS</b>	Estonie	<b>EE</b>
Bahreïn	<b>BH</b>	Etats-Unis d'Amérique	<b>US</b>
Bangladesh	<b>BD</b>	Ethiopie	<b>ET</b>
Barbade	<b>BB</b>	Ex Rep. Yougoslavie de Macedoine	<b>MK</b>
Bélarus	<b>BY</b>	Falkland, Îles (Malvinas)	<b>FK</b>
Belgique	<b>BE</b>	Fédération de Russie	<b>RU</b>
Belize	<b>BZ</b>	Fidji	<b>FJ</b>
Bénin*	<b>BJ</b>	Féroé, Îles	<b>FO</b>
Bermudes	<b>BM</b>	Finlande	<b>FI</b>
Bhoutan	<b>BT</b>	France	<b>FR</b>
Bolivie	<b>BO</b>	Gabon*	<b>GA</b>
Bonaire, Saint-Eustache et Saba	<b>BQ</b>	Gambie	<b>GM</b>
Bosnie-Herzégovine	<b>BA</b>	Géorgie	<b>GE</b>
Botswana	<b>BW</b>	Géorgie du Sud et les Îles Sandwich du Sud	<b>GS</b>
Bouvet, Île	<b>BV</b>	Ghana	<b>GH</b>
Brésil	<b>BR</b>	Gibraltar	<b>GI</b>
Brunéi Darussalam	<b>BN</b>	Grèce	<b>GR</b>
Bulgarie	<b>BG</b>	Grenade	<b>GD</b>
Burkina Faso*	<b>BF</b>	Groenland	<b>GL</b>
Burundi	<b>BI</b>	Guatemala	<b>GT</b>
Caïmanes, Îles	<b>KY</b>	Guernesey	<b>GG</b>
Cambodge	<b>KH</b>	Guinée*	<b>GN</b>
Cameroun*	<b>CM</b>	Guinée-Bissau*	<b>GW</b>
Canada	<b>CA</b>	Guinée Equatoriale*	<b>GQ</b>
Cap-Vert	<b>CV</b>	Guyana	<b>GY</b>
Centrafricaine, République*	<b>CF</b>	Haïti	<b>HT</b>

Chili	<b>CL</b>	Honduras	<b>HN</b>
Chine	<b>CN</b>	Hong Kong	<b>HK</b>
Chypre	<b>CY</b>	Hongrie	<b>HU</b>
Colombie	<b>CO</b>	Île de Man	<b>IM</b>
Comores*	<b>KM</b>	Îles Vierges (Britanniques)	<b>VG</b>
Congo*	<b>CG</b>	Inde	<b>IN</b>
Congo(Rép.Démocratique)	<b>CD</b>	Indonésie	<b>ID</b>
Iran(République Islamique d')	<b>IR</b>	Norvège	<b>NO</b>
Iraq	<b>IQ</b>	Nouvelle-Zélande	<b>NZ</b>
Irlande	<b>IE</b>	Oman	<b>OM</b>
Islande	<b>IS</b>	Ouganda	<b>UG</b>
Israël	<b>IL</b>	Ouzbékistan	<b>UZ</b>
Italie	<b>IT</b>	Pakistan	<b>PK</b>
Jamaïque	<b>JM</b>	Palaos	<b>PW</b>
Japon	<b>JP</b>	Panama	<b>PA</b>
Jersey	<b>JE</b>	Papouasie-Nouvelle-Guinée	<b>PG</b>
Jordanie	<b>JO</b>	Paraguay	<b>PY</b>
Kazakhstan	<b>KZ</b>	Pays-Bas	<b>NL</b>
Kenya	<b>KE</b>	Pérou	<b>PE</b>
Kirghizistan	<b>KG</b>	Philippines	<b>PH</b>
Kiribati	<b>KI</b>	Pologne	<b>PL</b>
Koweït	<b>KW</b>	Portugal	<b>PT</b>
Laos	<b>LA</b>	Qatar	<b>QA</b>
Lesotho	<b>LS</b>	Région admin. Spéciale de Hong Kong (Rep. Populaire de Chine)	<b>HK</b>
Lettonie	<b>LV</b>	Roumanie	<b>RO</b>
Liban	<b>LB</b>	Royaume Uni (Grande Bretagne)	<b>GB</b>
Libéria	<b>LR</b>	Rwanda	<b>RW</b>
Libye	<b>LY</b>	Sahara Occidental	<b>EH</b>
Liechtenstein	<b>LI</b>	Sainte-Hélène	<b>SH</b>
Lituanie	<b>LT</b>	Saint-Kitts-et-Nevis	<b>KN</b>
Luxembourg	<b>LU</b>	Sainte-Lucie	<b>LC</b>
Macao	<b>MO</b>	Saint-Marin	<b>SM</b>
Macédoine	<b>MK</b>	Saint-Marin (Partie Néerlandaise)	<b>SX</b>
Madagascar	<b>MG</b>	Saint-Siège(Vatican)	<b>VA</b>
Malaisie	<b>MY</b>	Saint-Vincent-et-les Grenadines(a,b)	<b>VC</b>
Malawi	<b>MW</b>	Salomon, Îles	<b>SB</b>
Maldives	<b>MV</b>	Samoa	<b>WS</b>
Mali*	<b>ML</b>	SaoTomé-et-Principe	<b>ST</b>
Malte	<b>MT</b>	Sénégal*	<b>SN</b>
Mariannes du Nord, Îles	<b>MP</b>	Serbie	<b>RS</b>
Maroc	<b>MA</b>	Seychelles	<b>SC</b>
Maurice	<b>MU</b>	Sierra Leone	<b>SL</b>
Mauritanie*	<b>MR</b>	Singapour	<b>SG</b>
Mexique	<b>MX</b>	Slovaquie	<b>SK</b>
Moldova	<b>MD</b>	Slovénie	<b>SI</b>
Monaco	<b>MC</b>	Somalie	<b>SO</b>

Mongolie	<b>MN</b>	Soudan	<b>SD</b>
Monténégro	<b>ME</b>	SriLanka	<b>LK</b>
Montserrat	<b>MS</b>	Suède	<b>SE</b>
Mozambique	<b>MZ</b>	Suisse	<b>CH</b>
Myanmar(Birmanie)	<b>MM</b>	Suriname	<b>SR</b>
Namibie	<b>NA</b>	Swaziland	<b>SZ</b>
Nauru	<b>NR</b>	Syrie	<b>SY</b>
Népal	<b>NP</b>	Tadjikistan	<b>TJ</b>
Nicaragua	<b>NI</b>	Taiwan,Province de Chine	<b>TW</b>
Niger*	<b>NE</b>	Tanzanie (Rép.-Unie)	<b>TZ</b>
Nigéria	<b>NG</b>	Tchad*	<b>TD</b>
Thaïlande	<b>TH</b>	Tchèque,République	<b>CZ</b>
Timor Oriental	<b>TP</b>	Ukraine	<b>UA</b>
Togo*	<b>TG</b>	Uruguay	<b>UY</b>
Tonga	<b>TO</b>	Vanuata	<b>VU</b>
Trinité-et-Tobago	<b>TT</b>	Venezuela	<b>VE</b>
Tunisie	<b>TN</b>	VietNam	<b>VN</b>
Turkménistan	<b>TM</b>	Yémen	<b>YE</b>
Turks et Caïques,Îles	<b>TC</b>	Yougoslavie	<b>YU</b>
Turquie	<b>TR</b>	Zambie	<b>ZM</b>
Tuvalu	<b>TV</b>	Zimbabwe	<b>ZW</b>

**ORGANISATIONS INTERNATIONALES DELIVRANT OU ENREGISTRANT DES TITRES DE PROPRIETE INDUSTRIELLE**

Bureau Benelux des marques et des dessins et modèles industriels	<b>BX</b>
Office Communautaire des variétés végétales (Communauté Européenne (OCVV))	<b>QZ</b>
Office de l'harmonisation dans le marché intérieur (Marque, dessins et modèles)	<b>EM</b>
Office des Brevets du conseil de Coopération des Etats du Golf (CCG)	<b>GC</b>
Office Européen des Brevets (OEB)	<b>EP</b>
Organisation Mondiale de la Propriété Intellectuelle (OMPI)	<b>WO</b>
Bureau International de l'OMPI	<b>IB</b>
Organisation Africaine de la Propriété Intellectuelle (OAPI)	<b>OA</b>
Organisation Eurasienne des Brevets (OEAB)	<b>EA</b>
Organisation Régionale Africaine de la Propriété Industrielle (ARIPO)	<b>AP</b>

\*Etats membres de l'OAPI

**CODES UTILISES EN MATIERE D'INSCRIPTIONS DANS  
LE REGISTRE SPECIAL DES MARQUES DE PRODUITS OU DE SERVICES  
ET DES DESSINS OU MODELES INDUSTRIELS**

- (1) Numéro d'enregistrement.
- (2) Numéro de dépôt ou de procès-verbal.
- (3) Nature de l'inscription.
- (4) Nom du bénéficiaire de l'inscription, nouvelle adresse ou dénomination, etc.
- (5) Le(s) numéro(s) de l'inscription.
- (6) Date(s) d'inscription.

**CODES UTILISES EN MATIERE DE DOCUMENTATION  
DE DESSINS ET MODELES INDUSTRIELS**

- (11) Numéro d'enregistrement.
- (21) Numéro de dépôt ou de P.V.
- (22) Date de dépôt.
- (30) Priorité(s) : Date(s), pays (code de la norme ST. 3 de l'OMPI) et numéro(s).
- (51) Classification internationale des dessins et modèles industriels  
(Classification de LOCARNO).
- (54) Désignation précise de(s) produit(s) au(x) quel(s) le(s) dessin(s) ou modèle(s) industriel(s)  
est (sont) destiné(s) à être incorporés : Titre du (des) dessin(s) ou modèle(s) industriel(s)
- (55) Reproduction du dessin ou modèle industriel (par exemple, dessin, photographie).
- (71) Nom(s) et adresse(s) du (des) déposant(s).
- (72) Nom(s) et adresse(s) de(s) auteur(s) de(s) dessin(s) ou modèle(s) industriel(s).
- (74) Nom et adresse du mandataire.

**CODES UTILISES EN MATIERE DE DESSINS  
ET MODELES INDUSTRIELS RENOUVELES**

- (1) Numéro d'enregistrement.
- (2) Numéro et date de dépôt.
- (3) Classe(s) internationale(s).
- (4) Titre du (des) dessin(s) ou modèle(s) industriel(s).
- (5) Nom(s) et adresse(s) du (des) déposant(s).
- (6) Nom(s) et adresse(s) de(s) auteur(s).
- (7) Numéro du renouvellement.
- (8) Nom et adresse du Mandataire.

**CLASSIFICATION INTERNATIONALE POUR LES DESSINS ET MODELES INDUSTRIELS ETABLIE EN VERTU  
DE L'ARRANGEMENT DE LOCARNO DU 8 OCTOBRE 1968 (9<sup>ème</sup> ÉDITION)**

- Classe 1 Produits alimentaires :** Boulangerie, biscuits, pâtisserie, pâtes et autres produits à base de céréales, chocolats, confiserie, glaces; fruits et légumes; fromages, beurre et succédanés du beurre, autres produits laitiers; produits de boucherie, de charcuterie et de poissonnerie; aliments pour animaux.
- Classe 2 Articles d'habillement et mercerie :** Sous- vêtements, lingerie, corsets, soutiens-gorge, vêtements de nuit; vêtements; articles de chapellerie; chaussures, bas et chaussettes; cravates, écharpes, foulards et mou- choirs; ganterie; mercerie et accessoires d'habillement.
- Classe 3 Articles de voyages, étuis, parasols et objets personnels, non compris dans d'autres classes :** Malles, valises, serviettes, sacs à main, porte-clés, étuis adaptés à leur contenu, portefeuilles; parapluies, parasols, ombrelles et cannes; éventails.
- Classe 4 Brosserie :** Brosses, pinceaux et balais de nettoyage; brosses et pinceaux de toilette, brosses pour vêtements et brosses à chaussures; brosses pour machines; brosses et pinceaux à peindre, pinceaux pour cuisiner.
- Classe 5 Articles textiles non confectionnés, feuilles de matière artificielle ou naturelle :** Filés, dentelles; broderies; rubans, galons et autres articles de passemen- terie; tissus et étoffes; feuilles de matière artificielle ou naturelle.
- Classe 6 Ameublement :** Lits et sièges; tables et meubles; meubles de rangement; meubles combinés; autres pièces de mobilier et parties de meubles; miroirs et cadres; cintres; matelas et coussins; rideaux et stores intérieurs; tapis de sol, paillassons et carpettes; tapisseries; couvertures, linge de maison et de table.
- Classe 7 Articles de ménage non compris dans d'autres classes :** Vaisselle et verrerie; appareils, ustensiles et récipients pour la cuisson; couteaux de table, fourchettes, cuillers; appareils et ustensiles, mus manuellement, pour préparer la nourriture ou les boissons; fers à repasser, ustensiles pour laver, nettoyer ou sécher; autres ustensiles de table; autres récipients de ménage; accessoires de cheminée d'appartement.
- Classe 8 Outils et quincaillerie :** Outils et instruments servant à forer, à fraiser ou à creuser; marteaux, outils et instruments analogues; outils et instruments tranchants; tournevis, outils et instruments analogues; autres outils et instruments; poignées, boutons et gonds; dispositifs de verrouillage ou de fermeture. Moyens de fixation, de soutien ou de montage, non compris dans d'autres classes; ferrures et dispositifs analogues; râteliers à bicyclettes.
- Classe 9 Emballages et récipients pour le transport ou la manutention des marchandises :** Bouteilles, flacons, pots, bonbonnes, récipients munis d'un système à pression; bidons et fûts; boîtes, caisses, conteneurs, boîtes à conserves; cageots et paniers; sacs, sachets, tubes et capsules; cordes et matériaux de cerclage; moyens de fermeture et accessoires; palettes et plates- formes de manutention; poubelles et conteneurs pour ordures et leurs supports.
- Classe 10 Horlogerie et autres instruments de mesure, instruments de contrôle ou de signalisation :** Horloges, pendules et réveils; montres et montres-bracelets; autres instruments de mesure du temps; autres instruments, appareils et dispositifs de mesure; instruments, appareils et dispositifs de contrôle, de sécurité ou d'essai; appareils et dispositifs de signalisation; boîtes, boîtiers, cadrans, aiguilles et toutes les autres pièces et accessoires d'instruments de mesure, de contrôle ou de signalisation.
- Classe 11 Objets d'ornement :** Bijouterie et joaillerie; bibelots, ornements de table, de dessus de cheminée ou de mur, vases et pots à fleurs; médailles et insignes; fleurs, plantes et fruits artificiels; drapeaux, articles de décoration de fête.
- Classe 12 Moyens de transport ou de levage :** Véhicules à traction animale; chariots à main, brouettes; locomotives et matériel roulant pour les chemins de fer et tous autres véhicules sur rail; téléphériques, télésièges et remonte-pentes; élévateurs, appareils de levage ou de manutention; navires et bateaux; avions et autres véhicules aériens ou spatiaux; automobiles, autobus et camions; tracteurs; remorques et véhicules routiers; cycles et motocycles; voitures d'enfant, fauteuils roulants pour infirmes, brancards; véhicules à usages spéciaux; autres véhicules; pneus, bandages et chaînes antidérapantes pour véhicules; parties, équipements et accessoires de véhicules, non compris dans d'autres classes ou sous- classes.
- Classe 13 Appareils de production, de distribution ou de transformation de l'énergie électrique :** Générateurs et moteurs; transformateurs, redresseurs, piles et accumulateurs; matériel de distribution ou de commande d'énergie électrique.
- Classe 14 Appareils d'enregistrement, de télécom- munication ou de traitement de l'information :** Appareils d'enregistrement ou de reproduction de sons ou d'images; appareils pour le traitement de l'information ainsi que les appareils et dispositifs périphériques; appareils de télécommunication et de télécommande sans fil, amplificateurs-radios.
- Classe 15 Machines non comprises dans d'autres classes :** Moteurs; pompes et compresseurs; machines agricoles; machines pour bâtir; machines pour laver, nettoyer ou sécher; machines textiles, machines à coudre, à tricoter ou à broder, y compris leurs parties intégrantes; machines et appareils de réfrigération; machines-outils, machines à abraser, machines de fonderie.
- Classe 16 Articles de photographie, décinématographie ou d'optique :** Appareils pour photographier ou filmer; appareils de projection et visionneuses; appareils pour photocopier ou agrandir; appareils et ustensiles pour le développement; accessoires; articles d'optique.
- Classe 17 Instruments de musique :** Instruments à clavier; instruments à vent; instruments à cordes; instruments à percussion;



instruments mécaniques.

- Classe 18 Imprimerie et machines de bureau :** Machines à écrire ou à calculer; machines pour l'impression; caractères et signes typographiques; machines à relier, agrafeuses d'imprimerie, massicots.
- Classe 19 Papeterie, articles de bureau, matériel pour artistes ou d'enseignement :** Papier à écrire, cartes de correspondance et faire-part; articles de bureau; calendriers; livres, cahiers et objets d'aspect extérieur semblable; matériel et instruments pour écrire à la main, pour dessiner, pour peindre, pour sculpter, pour graver ou pour d'autres techniques artistiques; matériel d'enseignement; autres imprimés.
- Classe 20 Equipement de vente ou de publicité, signes indicateurs :** Distributeurs automatiques; matériel d'exposition ou de vente; signes indicateurs, dispositifs publicitaires.
- Classe 21 Jeux, jouets, tentes et articles de sport :** Jeux et jouets; appareils et articles de gymnastique ou de sport; autres articles d'amusement et de divertissement; tentes et accessoires.
- Classe 22 Armes, articles pyrotechniques, articles pour la chasse, la pêche et la destruction d'animaux nuisibles :** Armes à projectiles; autres armes; munitions, fusées et articles pyrotechniques; cibles et accessoires; articles pour la chasse ou la pêche; pièges, articles pour la destruction d'animaux nuisibles.
- Classe 23 Installations pour la distribution de fluides, installations sanitaires, de chauffage, de ventilation ou de conditionnement d'air, combustibles solides :** Installations pour la distribution de fluides; installations sanitaires; équipements pour le chauffage; ventilation et conditionnement d'air; combustibles solides.
- Classe 24 Médecine et laboratoires :** Appareils et installations pour médecins, hôpitaux ou laboratoires, instruments médicaux, instruments et ustensiles de laboratoire; prothèses; articles de pansement, de bandage et de soins médicaux.
- Classe 25 Constructions et éléments de construction :** Matériaux de construction; parties de construction préfabriquées ou préassemblées; maisons, garages et autres constructions; escaliers, échelles et échafaudages.
- Classe 26 Appareils d'éclairage :** Bougeoirs et chandeliers; torches, lampes et lanternes portatives; appareils d'éclairage public; sources lumineuses, électriques ou non; lampes, lampadaires, lustres, appliques murales ou de plafond, abat-jour, réflecteurs, lampes pour projecteurs de photographie ou de cinématographie; dispositifs lumineux de véhicules.
- Classe 27 Tabacs et articles pour fumeurs :** Tabacs, cigares et cigarettes; pipes, fume-cigares et fume-cigarettes; cendriers; allumettes; briquets; étuis à cigares, étuis à cigarettes, tabatières et pots à tabac.
- Classe 28 Produits pharmaceutiques ou cosmétiques, articles et équipements de toilette :** Produits pharmaceutiques; produits cosmétiques; articles de toilette et équipements pour soins de beauté; cheveux, barbes et moustaches postiches.
- Classe 29 Dispositifs et équipements contre le feu, pour la prévention d'accidents ou le sauvetage :** Dispositifs et équipements contre le feu; dispositifs et équipements pour la prévention d'accidents ou le sauvetage, non compris dans d'autres classes.
- Classe 30 Articles pour les soins et l'entretien des animaux :** Vêtements pour animaux; enclos, cages, niches et abris analogues; nourrisseurs et abreuvoirs; sellerie; fouets et aiguillons; litières et nids; perchoirs et autres accessoires de cages; marqueurs, marques et entraves; poteaux d'attache.
- Classe 31 Machines et appareils pour préparer la nourriture ou les boissons, non compris dans d'autres classes :** Machines et appareils pour préparer la nourriture et les boissons, non compris dans d'autres classes.
- Classe 32 Symboles graphiques et logos, motifs décoratifs pour surfaces, ornementation :** Symboles graphiques et logos, motifs décoratifs pour surfaces, ornementation.

## CLARIFICATION DU REGLEMENT RELATIF A L'EXTENSION DES DROITS SUITE A UNE NOUVELLE ADHESION A L'ACCORD DE BANGUI

### RESOLUTIONN°47/32

#### LE CONSEIL D'ADMINISTRATION DE L'ORGANISATION AFRICAINE DE LAPROPRIETE INTELLECTUELLE

- Vu L'accord portant révision de l'accord de Bangui du 02 Mars 1977 instituant une Organisation Africaine de la Propriété Intellectuelle et ses annexes ;
- Vu Les dispositions des articles 18 et 19 dudit Accord relatives Aux attributions et pouvoirs du Conseil d'Administration ;

**ADOpte** la clarification du règlement du 04 décembre 1988 relatif à l'extension des droits suite à une nouvelle adhésion à l'Accord de Bangui ci-après :

#### **Article 1er :**

Le Règlement du 04 décembre 1988 relatif à l'extension des droits suite à une nouvelle adhésion à l'Accord de Bangui est réaménagé ainsi qu'il suit :

#### **« Article 5 (nouveau) :**

Les titulaires des titres en vigueur à l'Organisation avant la production des effets de l'adhésion d'un Etat à l'accord de Bangui ou ceux dont la demande a été déposée avant cette date et qui

voudront étendre la protection dans ces Etats doivent formuler une demande d'extension à cet effet auprès de l'Organisation suivant les modalités fixées aux articles 6 à 18 ci-dessous.

Le renouvellement de la protection des titres qui n'ont pas fait l'objet d'extension avant l'échéance dudit renouvellement entraîne une extension automatique des effets de la protection à l'ensemble du territoire OAPI».

Le reste sans changement.

#### **Article 2 :**

La présente clarification, qui entre en vigueur à compter du 1<sup>er</sup> janvier 2008, s'applique aussi aux demandes d'extension en instance et sera publiée au Bulletin Officiel de l'Organisation.

Fait à Bangui le 17 décembre 2007

# STRUCTURES NATIONALES DE LIAISON (SNL)

## BENIN-Cotonou

### Agence Nationale de la Propriété Industrielle (ANAPI)

Tel.: (229) 21 31 02 40  
Fax.: (229) 21 30 30 24  
01 B.P. 363 Cotonou 01

## BURKINA FASO-Ouagadougou

### Direction Nationale de la Propriété Industrielle (DNPI)

(Ministère de l'Industrie, du Commerce et de l'Artisanat)  
Tél. : (226) 50 30 09 41  
Fax : (226) 50 33 05 63  
01 B.P. 258 Ouagadougou

## CAMEROUN-Yaoundé

### Direction du Développement Technologique et de la Propriété Industrielle

(Ministère des Mines, de l'Industrie et du Développement Technologique)  
Tel. : (237) 22 20 37 78  
Fax.: (237) 22 20 37 38  
B.P. 1652 Yaoundé

## CENTRAFRIQUE-Bangui

### Direction de la Propriété Industrielle (Ministère du Commerce et de l'Industrie)

Tél. : (236) 21 61 17 44  
Fax : (236) 21 61 76 53  
Avenue B. BOGANDA  
B.P. 1988 Bangui

## COMORES-Moroni

### Office comorien de la propriété intellectuelle

Tél. : 269 333 53 60  
Fax : 269 775 00 03  
B.P. 41 Moroni

## CONGO-Brazzaville

### Antenne Nationale de la Propriété Industrielle (ANPI)

(Ministère du Développement Industriel et de la Promotion du Secteur Privé)  
Tél. : (242) 581 56 57  
Fax : (242) 581 54 80  
B.P. : 72 Brazzaville

## COTE D'IVOIRE-Abidjan

### Office Ivoirien de la Propriété Industrielle (OIIPI)

Tel. : (225) 20 33 53 43/44  
Fax: (225) 20 33 53 45  
01 B.P. 2337 Abidjan

## GABON-Libreville

### Centre de la Propriété Industrielle du Gabon (CEPIG)

(Ministère du Commerce et du Développement Industriel, Chargé du NEPAD)  
Tel. : (241) 01 74 59 24  
Fax. : (241) 01 76 30 55  
B.P. : 1025 Libreville

## GUINEE-Conakry

### Service National de la Propriété Industrielle

(Ministère de l'Industrie, des Petites et Moyennes Entreprises)  
Tel. : (224) 30 41 17 20/60 58 53 61  
Fax: (224) 41 25 42/41 39 90  
B.P. 468 Conakry

## GUINEE BISSAU-Bissau

### Direction Générale de la Propriété Industrielle

(Ministère du Commerce, de l'Industrie et de la Promotion des Produits locaux)  
Tél : (245) 322 22 75  
Fax : (245) 322 37 65  
B.P. : 269 Bissau

## GUINEE EQUATORIALE-Malabo

### Direction de la Propriété Intellectuelle

(Conseil de la Recherche Scientifique et Technique - CICTE)  
Tel. : (240) 222 09 24 84  
Fax : (240) 333 09 33 13  
B.P. : 528 Malabo

## MALI-Bamako

### Centre Malien de la Propriété Industrielle (CEMAPI)

Tel. : (223) 20 29 90 90  
Fax: (223) 20 29 90 91  
B.P. : 278 Bamako

## MAURITANIE-Nouakchott

### Service de la Technologie et de la Propriété Industrielle

(Ministère du Commerce, de l'Industrie, de l'Artisanat et du Tourisme)  
Tel. : (222) 525 72 66  
Fax: (222) 525 69 37  
B.P. : 387 Nouakchott

## NIGER-Niamey

### Direction de l'Innovation et de la Propriété Intellectuelle

(Ministère des Mines et du Développement Industriel)  
Tél. : (227) 20 73 58 25  
Fax : (227) 20 73 21 50  
B.P. : 480 Niamey

## SENEGAL-Dakar

### Agence Sénégalaise pour la Propriété Industrielle et l'Innovation Technologique (ASPIT)

Tel. : (221) 33 869 47 70  
Fax: (221) 33 827 30 14  
B.P. : 4037 Dakar

## TCHAD-N'djamena

### Division de la Propriété Industrielle et de la Technologie

(Ministère du Commerce et de l'Industrie)

Tel. : (235) 22 52 08 67  
Fax: (235) 22 52 21 79  
B.P. : 424 N'Djamena

## TOGO-Lomé

### Institut National de la Propriété Industrielle et de la Technologie (INPIT)

Tel. : (228) 222 10 08  
Fax : (228) 222 44 70  
B.P. : 2339 Lomé



B.P. 887 Yaoundé-Cameroun Tél : (237) 22 20 57 00  
E-mail : oapi@oapi.int Fax : (237) 22 20 57 27

[www.oapi.int](http://www.oapi.int)

**DEUXIEME PARTIE**  
**DESSINS ET MODELES INDUSTRIELS**

(11) **04461**

(21) 4201500002

(22) 16.01.2015

(51) 9

(54) Emballages et récipients pour produits cosmétiques.

(55)

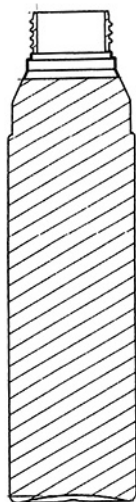

1.1

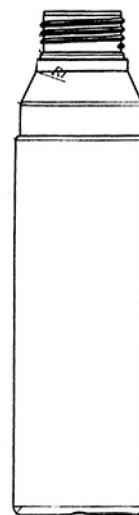

1.3

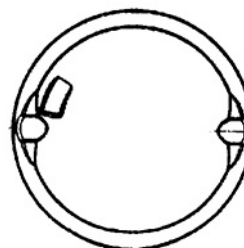

1.4



1.2

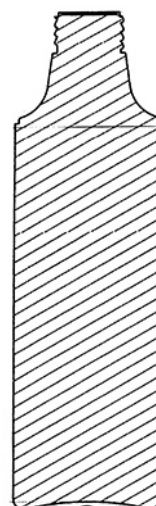

2.1

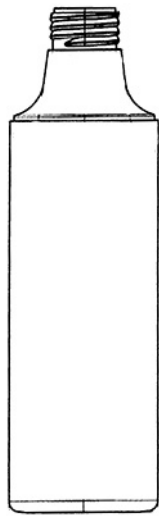

2.2

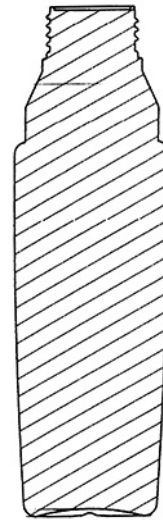

3.1

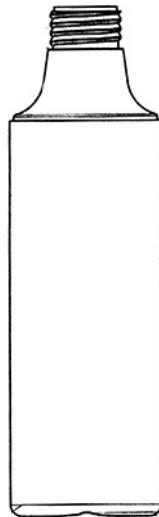

2.3

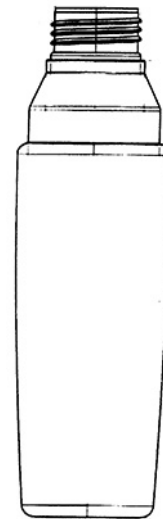

3.2

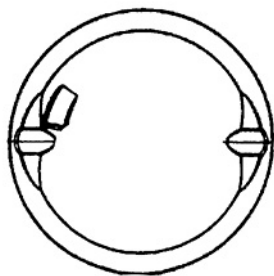

2.4

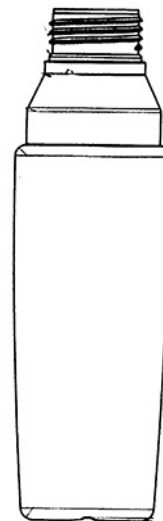

3.3

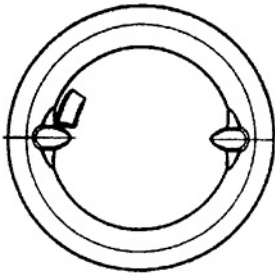

3.4

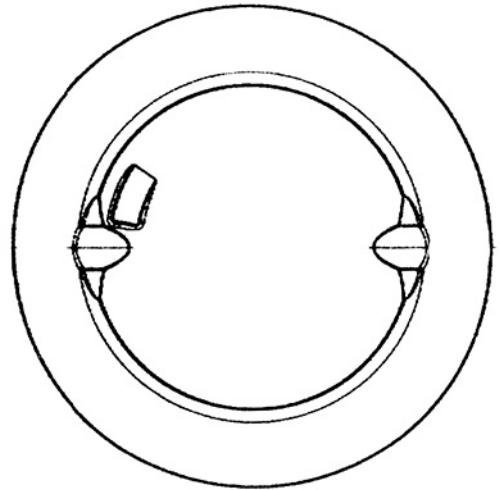

4.4

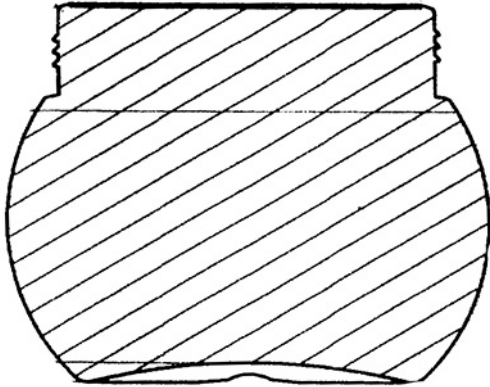

4.1

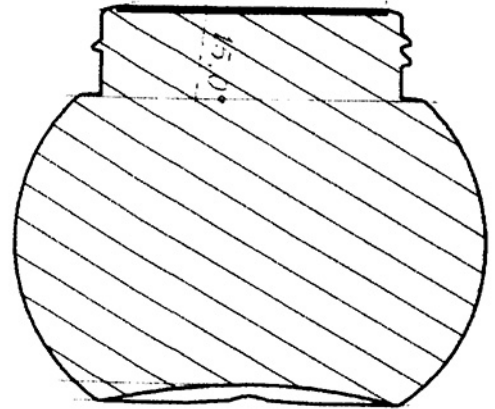

5.1

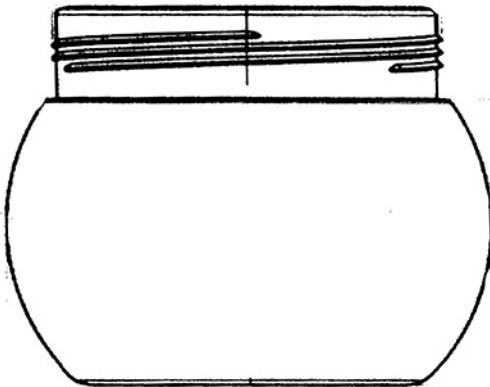

4.2

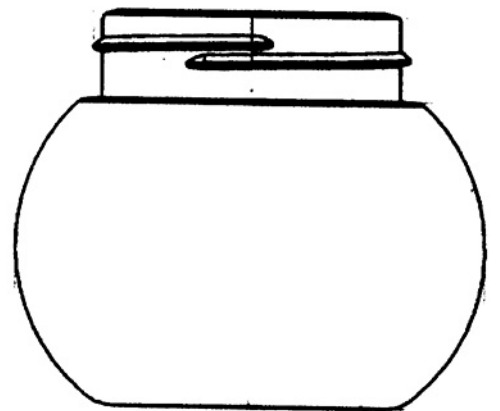

5.2

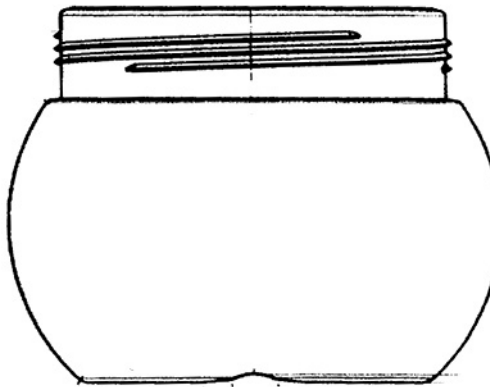

4.3

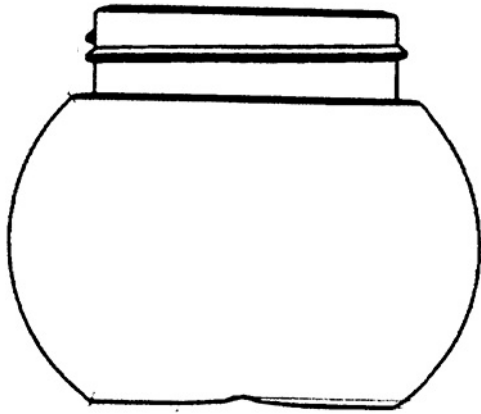

5.3

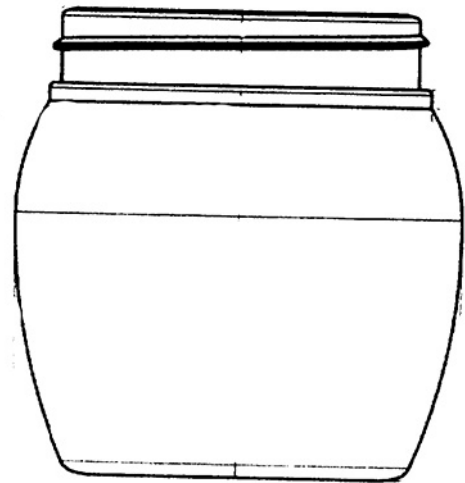

6.2

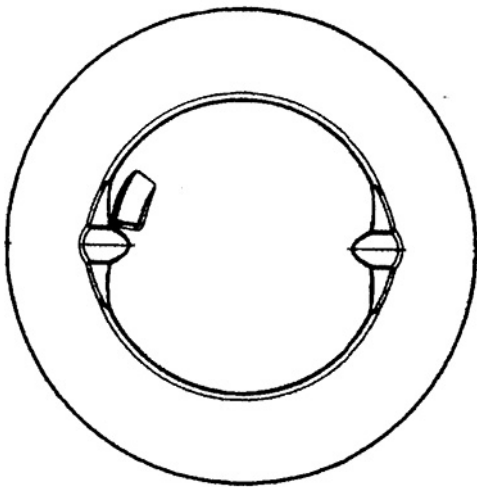

5.4

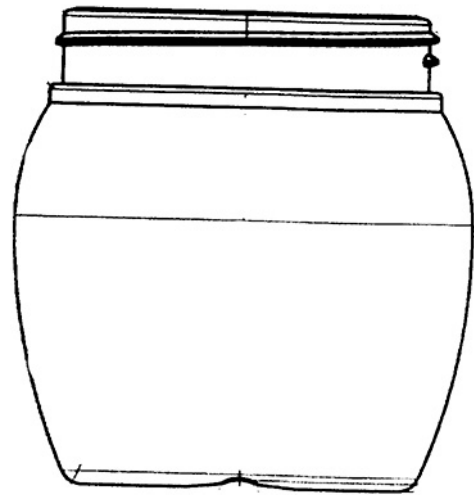

6.3

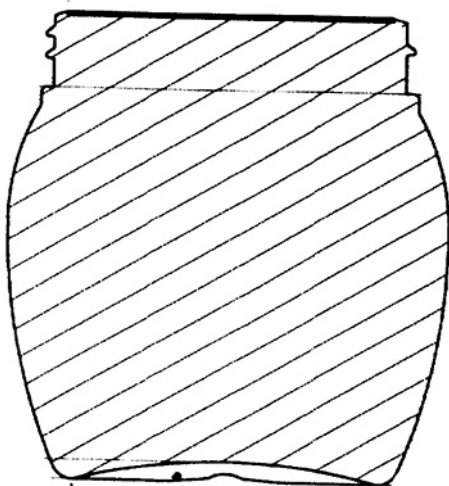

6.1

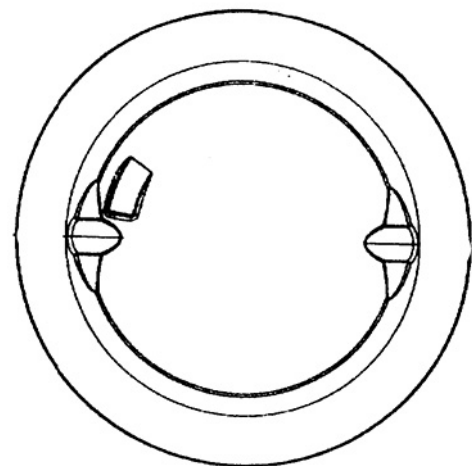

6.4



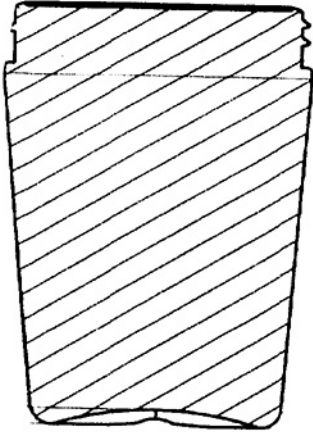

7.1

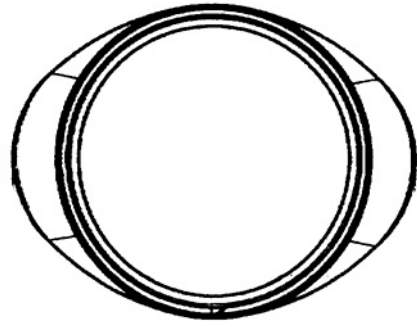

7.4

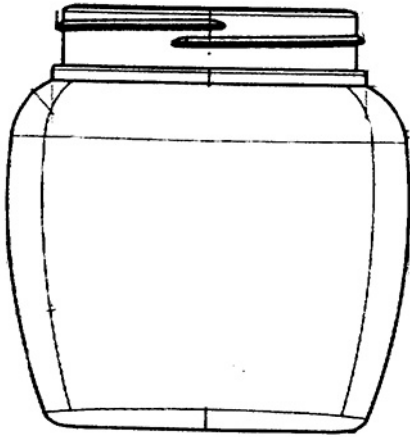

7.2

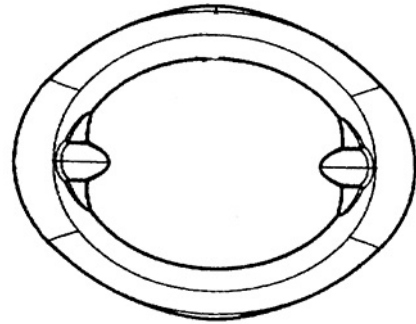

7.5

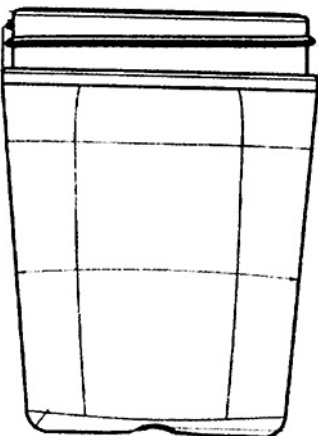

7.3

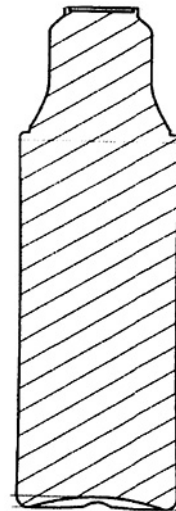

8.1

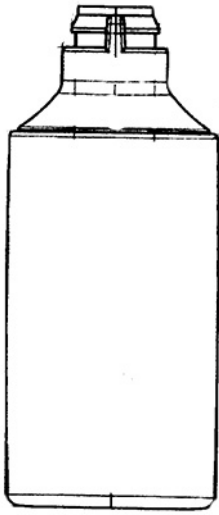

8.2

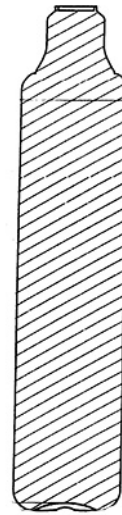

9.1

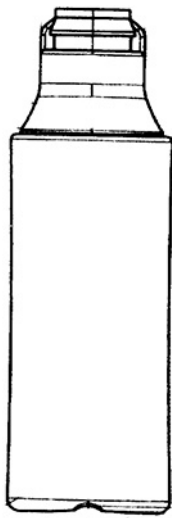

8.3

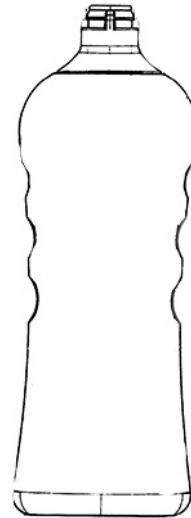

9.2

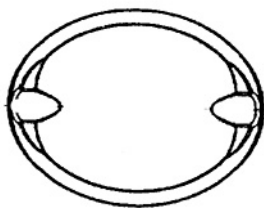

8.4

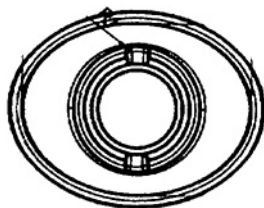

8.5

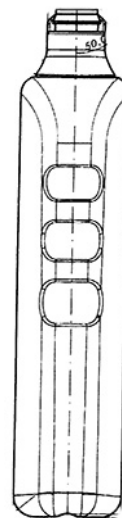

9.3

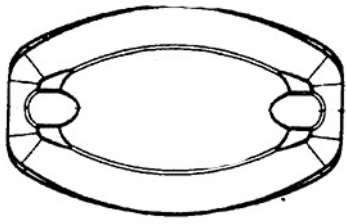

9.4

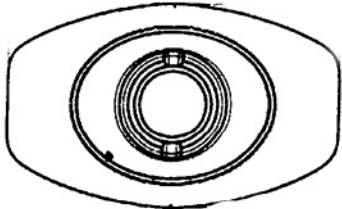

9.5

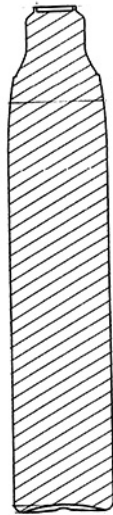

10.1

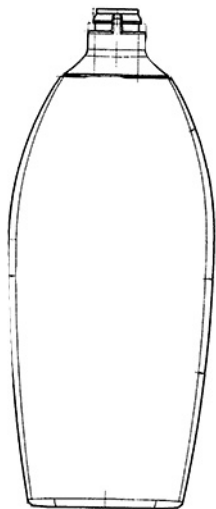

10.2



10.3

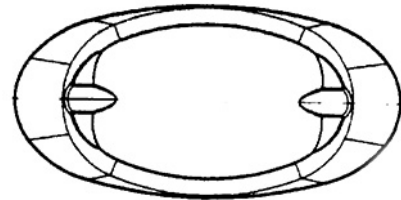

10.4

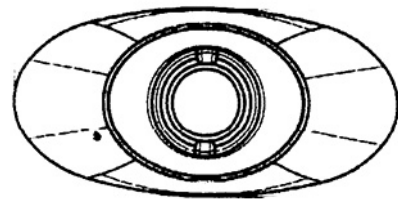

10.5



11.1

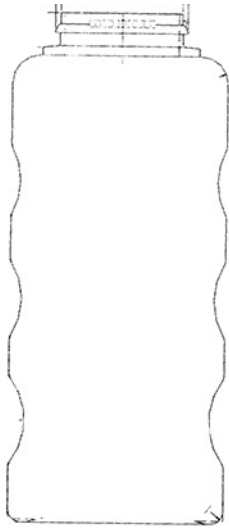

11.2

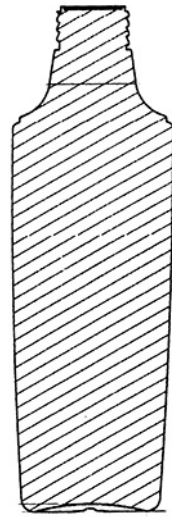

12.1

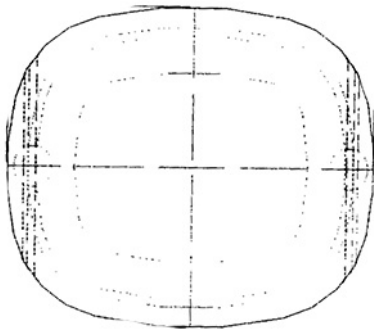

11.3

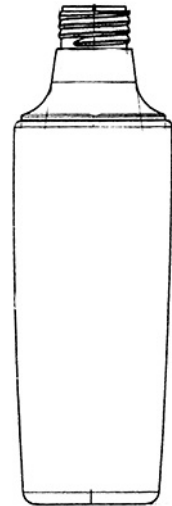

12.2



11.4

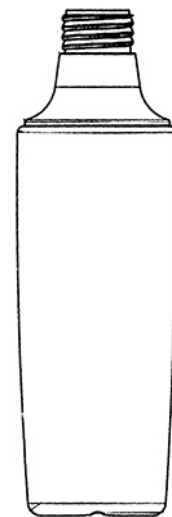

12.3

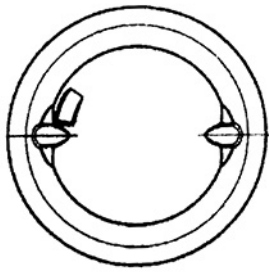

12.4

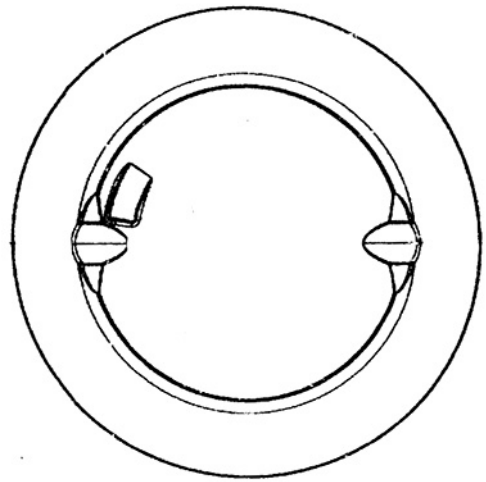

13.4

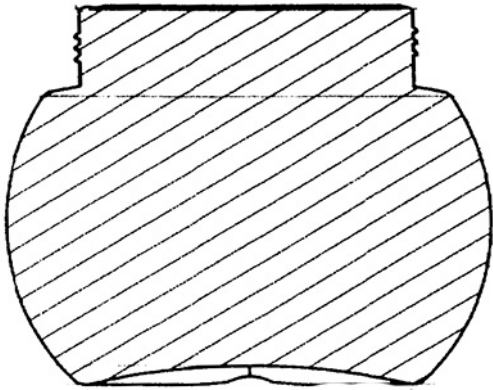

13.1

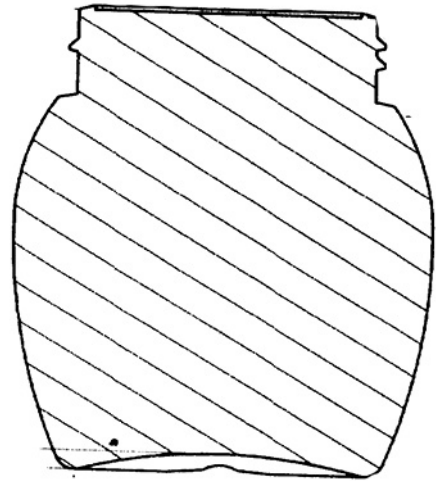

14.1

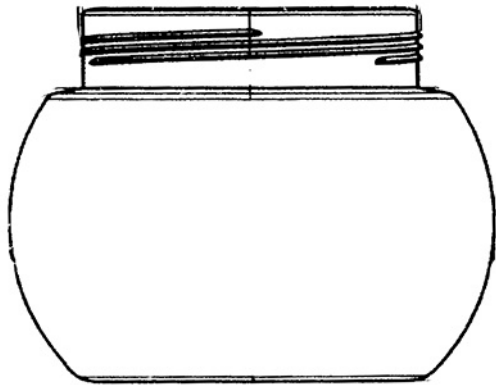

13.2

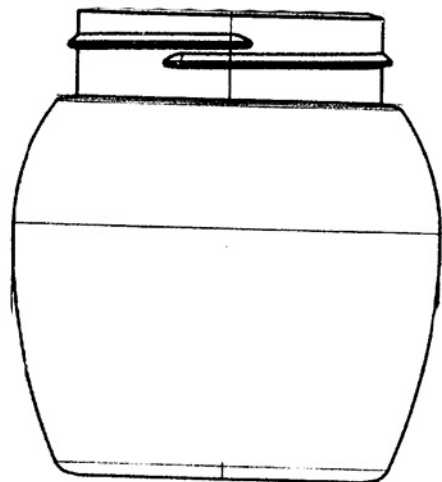

14.2

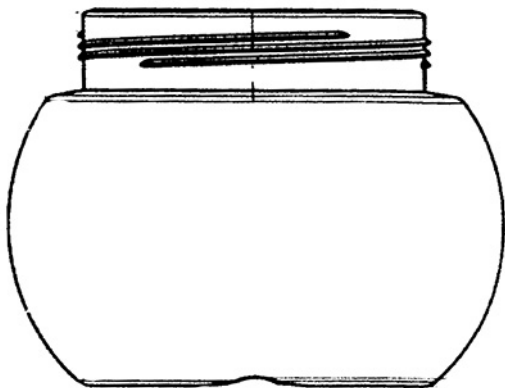

13.3

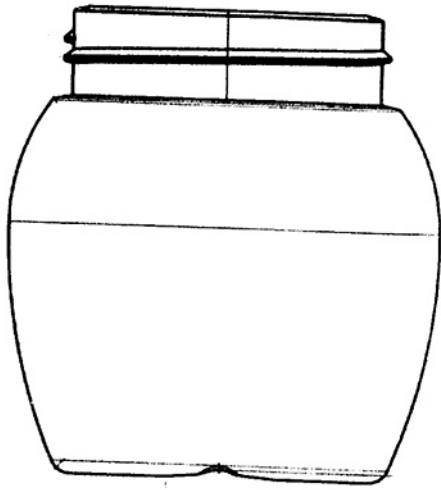

14.3

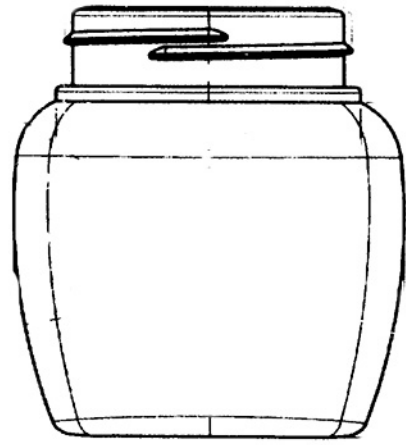

15.2

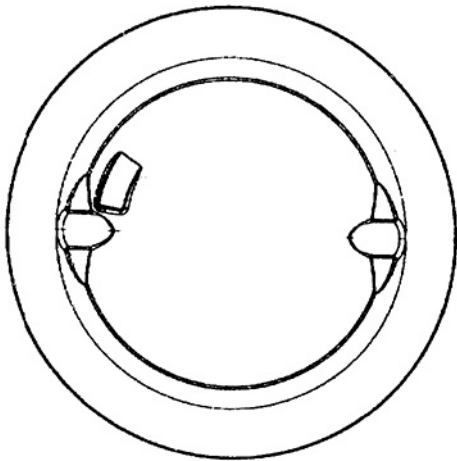

14.4

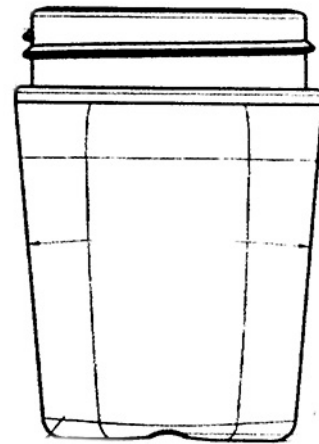

15.3

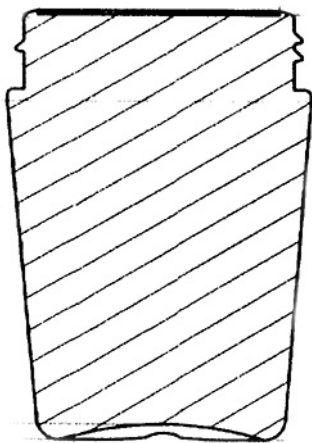

15.1

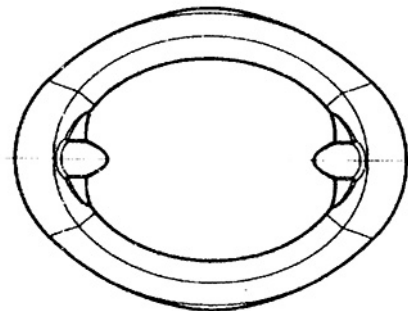

15.4

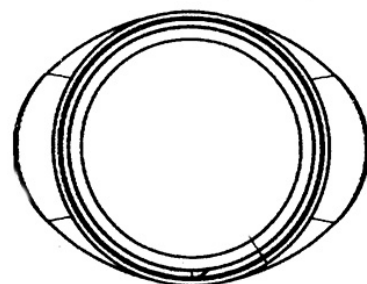

15.5

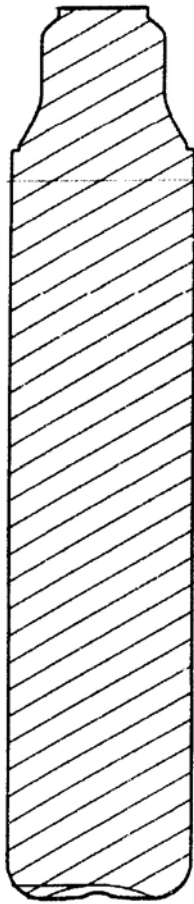

16.1

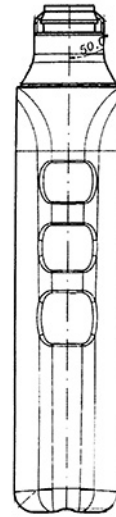

16.3

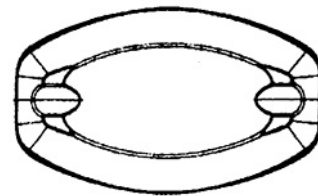

16.4

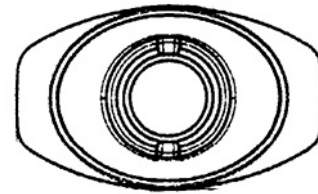

16.5

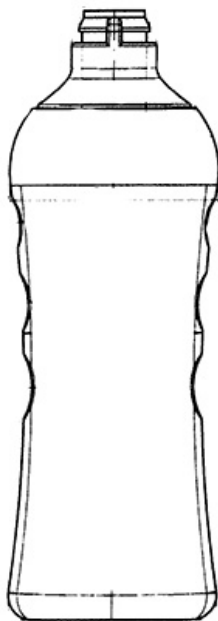

16.2

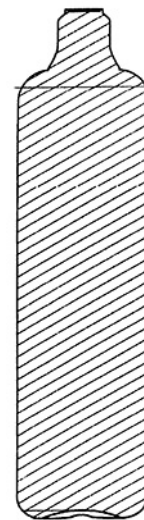

17.1

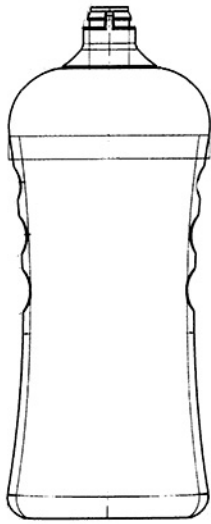

17.2

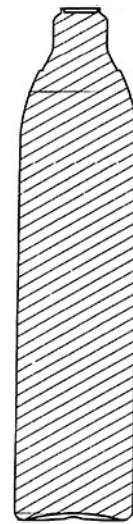

18.1

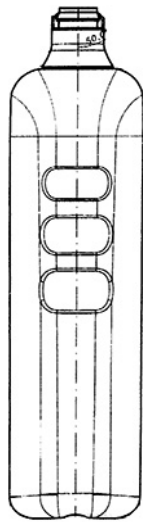

17.3

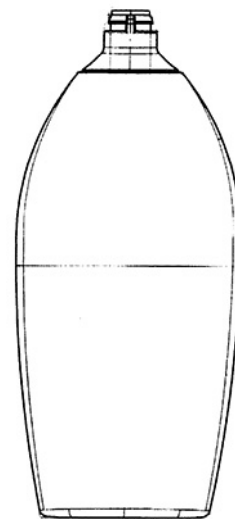

18.2

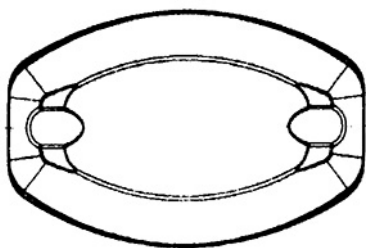

17.4



18.3

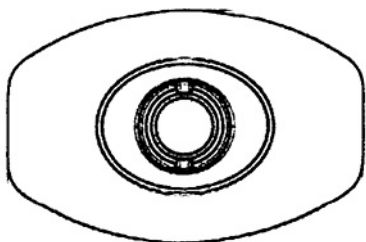

17.5



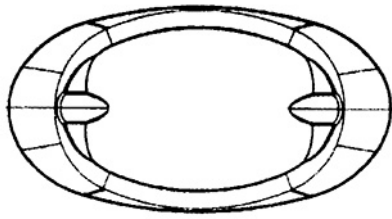

18.4

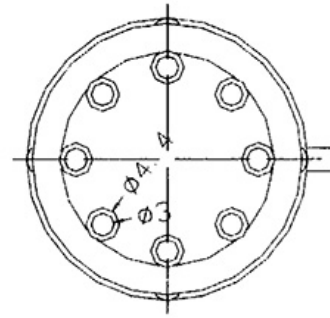

19.4

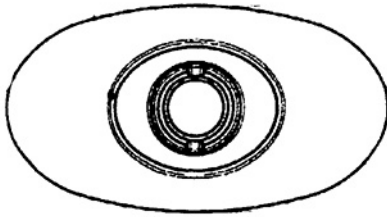

18.5

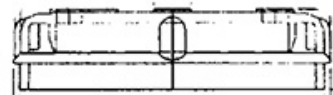

19.5

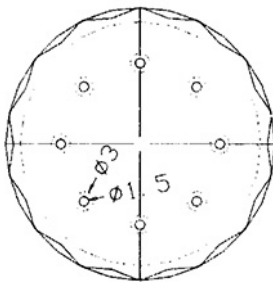

19.1

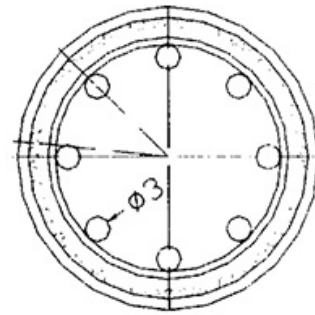

19.6

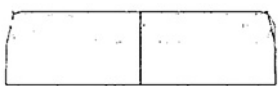

19.2

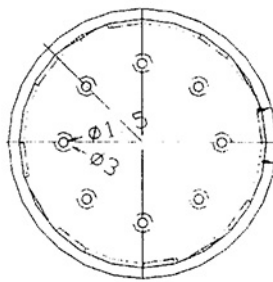

19.3

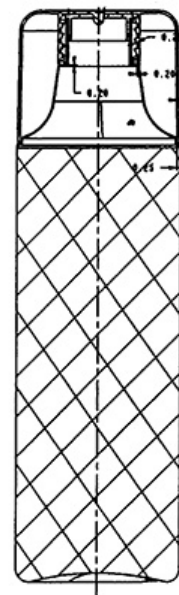

20.1

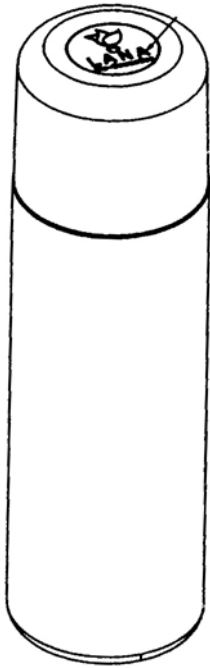

20.2



20.6

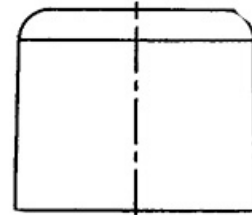

20.7



20.3

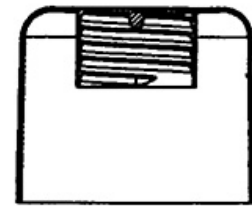

20.8

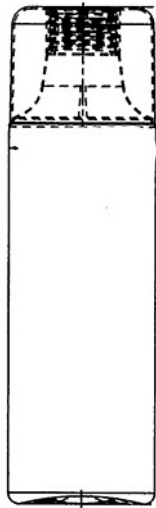

20.4

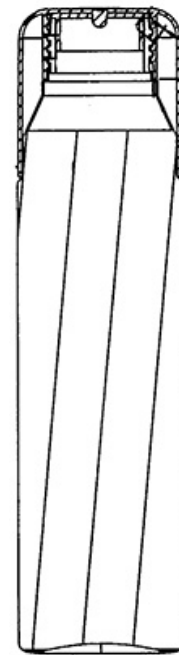

21.1



20.5

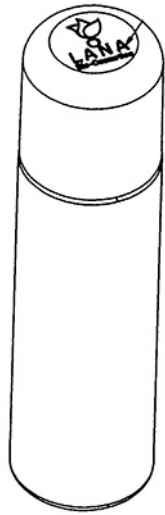

21.2



21.5

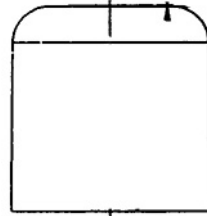

21.6



21.3

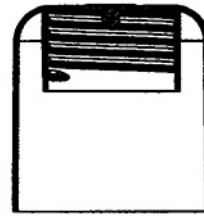

21.7



21.4

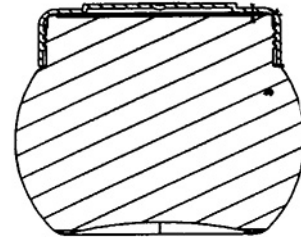

22.1



22.2

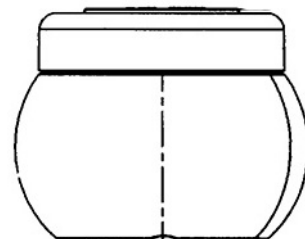

22.3

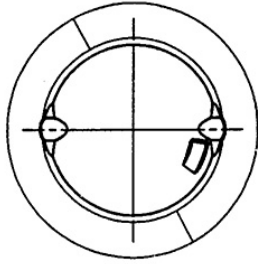

22.4



23.2



22.5



23.3



22.6

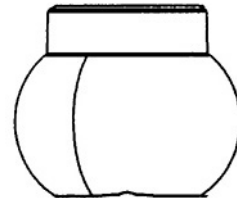

23.4



22.7

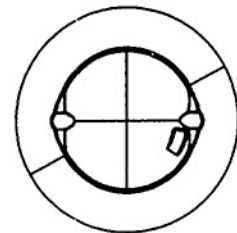

23.5



22.8



23.6

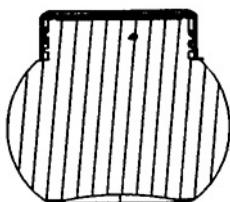

23.1



23.7

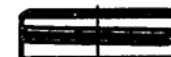

23.8



23.9

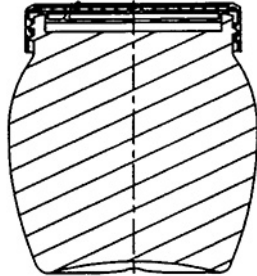

24.1



24.2

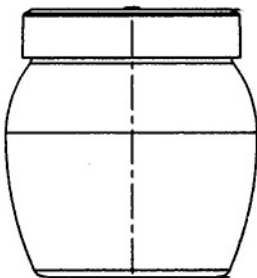

24.3

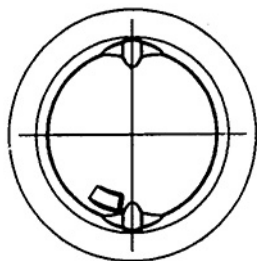

24.4



24.5



24.6

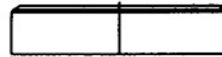

24.7



24.8

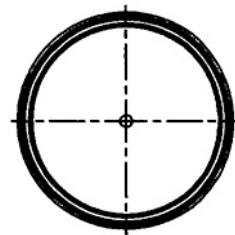

24.9

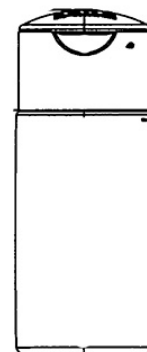

25.1

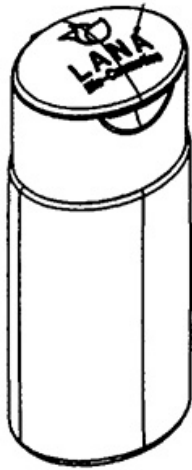

25.2

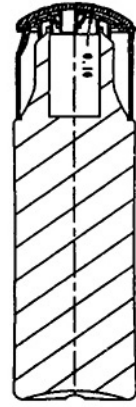

25.5

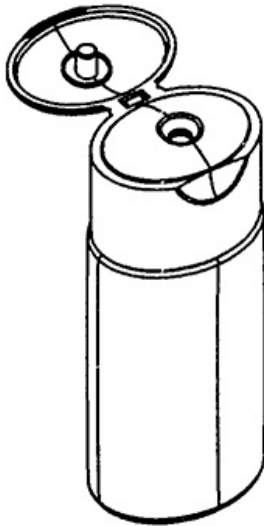

25.3



25.6

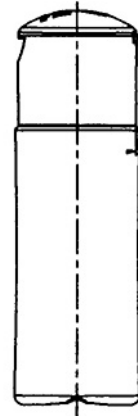

25.7



25.4

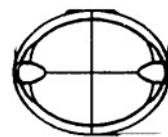

25.8

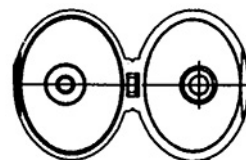

25.9

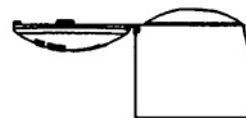

25.10

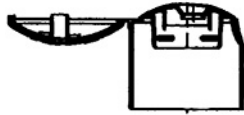

25.11

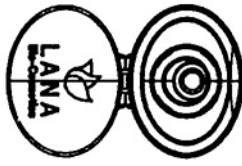

25.12

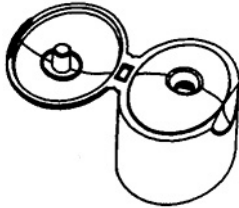

25.13

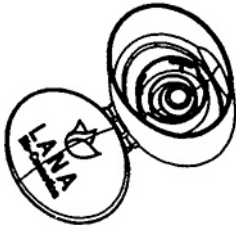

25.14

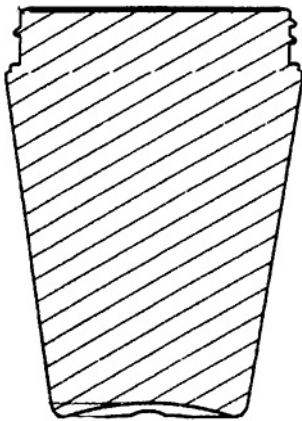

26.1



26.2

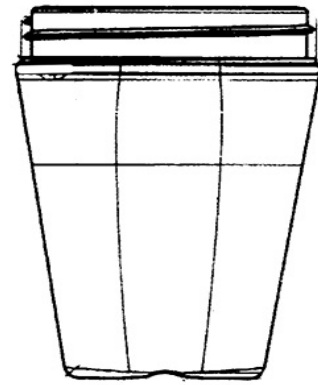

26.3

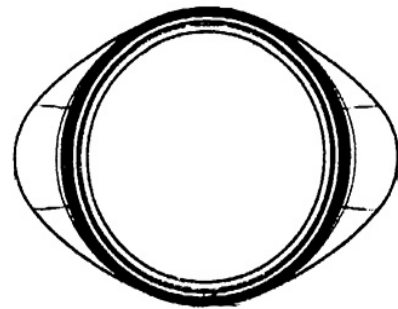

26.4

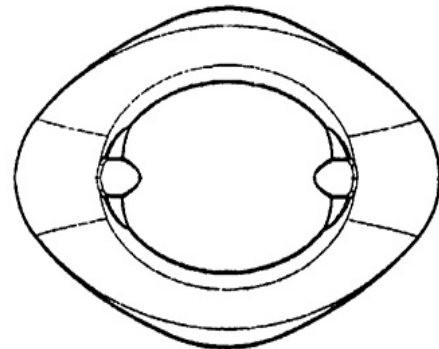

26.5

(71) LANA BIO-COSMETICS, B.P. 914, DOUALA (CM)

(72) ALI AWADA, B.P. 914, DOUALA (CM)

(74) Cabinet EKANI-CONSEILS, B.P. 5852 YAOUNDE (CM).

(11) **04462**

(21) 4201500005

(22) 23.12.2014

(51) 2

(54) Chaussures plastiques.

(55)



1.1



1.2



2.1



2.2

(71) WIM PLAST, 16 B.P. 1777, ABIDJAN 16 (CI).

(11) 04463

(21) 4201500006

(22) 11.08.2014

(51) 2

(54) Chaussures plastiques.

(55)



1.1



1.2



2.1





2.2



4.1



3.1



4.2



3.2

(71) Z.H.A PLASTICO, 26 B.P. 16 , ABIDJAN 26 (CI).

(11) **04464**

(21) 4201500007

(22) 30.12.2014

(51) 2

(54) Sandales.

(55)



1.1



1.2



2.1



2.2



3.1



3.2

(71) SOCIETE YAHO, Zone Industrielle de Yopougon, 12 B.P. 1934, ABIDJAN 12 (CI)

(74) Cabinet Eric BABLY, Cocody Val Doyen, face Jardin Municipal, 08 B.P. 3819, ABIDJAN 08 (CI).

(11) **04465**

(21) 4201500010

(22) 30.12.2014

(51) 9

(54) Emballages et récipients pour le transport ou la manutention de marchandises.

(55)



1.1



2.1



3.1



4.1

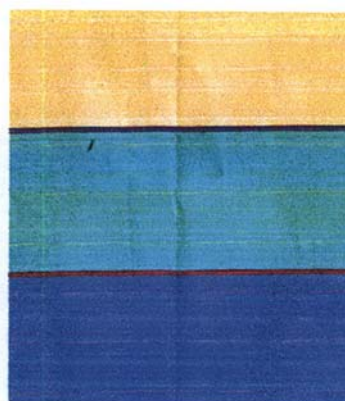

5.1

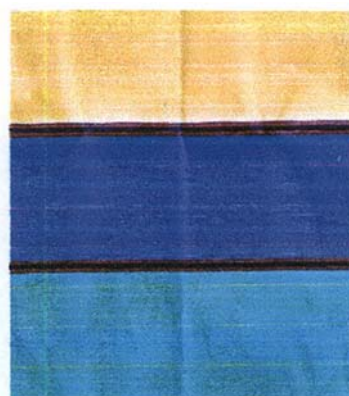

6.1



7.1



8.1

(71) Etablissements BARRY MITTY et Frères, Quartier Madina dispensaire, Commune de Matam, B.P. 4643, CONAKRY (GN).

(11) **04466**

(21) 4201500012

(22) 08.01.2015

(51) 2

(54) Articles d'habillement.

(55)



1.1



2.1



3.1



4.1



5.1



6.1



7.1



8.1



11.1



9.1



12.1



10.1

(71) Etablissements Sidi & Frères, Quartier Madina, Commune de Matam, B.P. 2760, CONAKRY (GN).

(11) **04467**

(21) 4201500014

(22) 08.01.2015

(51) 2

(54) Chaussures.

(55)



1.1



2.1



3.1



4.1



5.1



6.1



7.1



8.1



9.1



10.1

(71) Monsieur BAH Boubacar, Madina, Commune de Matam B.P. 6283, CONAKRY (GN).

(11) 04468

(21) 4201500018

(22) 07.01.2015

(51) 2

(54) Chaussures.

(55)



1.1



2.1



3.1



4.1



5.1



6.1



7.1



8.1



9.1



10.1



13.1



11.1



14.1



12.1



15.1





16.1



17.1



18.1

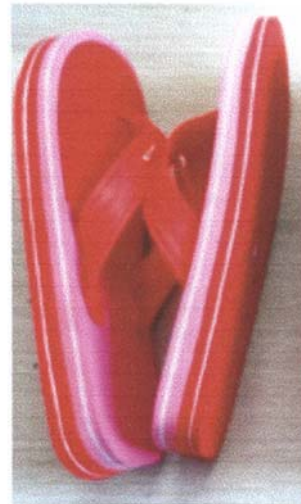

19.1



20.1



21.1



22.1



23.1



24.1



25.1



26.1

(71) Messieurs Souleymane DIALLO et Abdoulaye BARRY Koba, Commerçant import-export Quartier Madina, Commune de Matam, B.P. 5596, CONAKRY (GN).

(11) **04469**

(21) 4201500019

(22) 07.01.2015

(51) 2

(54) Chaussures.

(55)



1.1



2.1



3.1



4.1



5.1



6.1



7.1



8.1



9.1



10.1



11.1



12.1



13.1



18.1



14.1



19.1



15.1



20.1



16.1



21.1



17.1



22.1



23.1



27.1



24.1



28.1



25.1



29.1



26.1



30.1



31.1



32.1



33.1



34.1



35.1



36.1



37.1



38.1



39.1



43.1



40.1



44.1



41.1



45.1



42.1



46.1



47.1



51.1



48.1



52.1

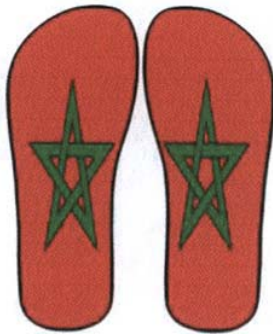

49.1



53.1



50.1



54.1





55.1



59.1



56.1



60.1



57.1



61.1



58.1



62.1



63.1



67.1



64.1



68.1



65.1



69.1



66.1



70.1



71.1



75.1



72.1



76.1



73.1



77.1



74.1



78.1



79.1



83.1



80.1



84.1



81.1

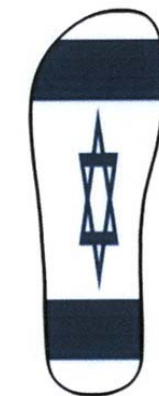

85.1



82.1



86.1



87.1



88.1



89.1



90.1



91.1



92.1

(71) Messieurs Souleymane DIALLO et Abdoulaye BARRY Koba, Commerçant import-export Quartier Madina, Commune de Matam, B.P. 5596, CONAKRY (GN).

(11) **04470**

(21) 4201400226

(22) 11.07.2014

(51) 11

(54) Appareil de ventilation.

(55)



1.1



2.1

(71) SOCIETE STAR CREATIVE, B.P. 15205, DOUALA (CM)

(72) MILLAT (CM).

(71) Ets LA RUCHE, s/c Monsieur BIPOUPOUT Jacques-Calvin, B.P. 12662, YAOUNDE (CM)

(72) Luc BELL Anatole MANDENG, s/c B.P. 12662, YAOUNDE (CM).

(11) **04472**

(21) 4201500033

(22) 26.01.2015

(51) 2

(54) Chaussures.

(55)



1.1



1.2

(11) **04471**

(21) 4201400447

(22) 30.12.2014

(51) 19

(54) Etiquettes.

(55)



1.1



2.1



3.1



2.1



3.1



4.1



5.1



6.1



7.1

(71) Messieurs DIALLO Mamadou Tahirou et Boubacar DIALLO, Madina, Commune de Matam, B.P. 3160, CONAKRY (GN).

(11) **04473**

(21) 4201500051

(22) 06.01.2015

(51) 7

(54) Articles de ménage.

(55)



1.1



2.1



2.2

(71) TRANSFORMATION INDUSTRIELLE DU PLASTIQUE (T.I.P.), 01 B.P. 7549, ABIDJAN 01 (CI).

(11) **04474**

(21) 4201500052

(22) 18.12.2014

(51) 2

(54) Chaussures plastiques.

(55)



1.1



4.1

(71) INDUSTRIE DU PLASTIQUE EN CÔTE D'IVOIRE (IPCI), 05 B.P. 2827, ABIDJAN 05 (CI).



2.1



3.1

(11) **04475**

(21) 4201500053

(22) 15.12.2014

(51) 2

(54) Chaussures plastiques.

(55)



1.1





1.2



3.1



2.1



3.2



2.2



4.1



4.2



6.1



5.1



6.2



5.2



7.1



7.2



8.2

(71) YAHOO, 23 B.P. 3017, ABIDJAN 23 (CI).



8.1

(11) **04476**

(21) 4201500054

(22) 09.01.2015

(51) 2

(54) Chaussures plastiques.

(55)



1.1



1.2



2.1



2.2

(11) **04477**

(21) 4201500055

(22) 06.01.2015

(51) 2

(54) Chaussure plastique.

(55)



1.1



1.2



1.3



1.4

(71) GIP - CI (GENERAL INDUSTRIE ET POLYMERE CÔTE D'IVOIRE), 10 B.P. 2074, ABIDJAN 10 (CI).

(71) WIM - PLAST, 16 B.P. 1777, ABIDJAN 16 (CI).

(11) **04478**

(21) 4201500059

(22) 16.01.2015

(51) 2

(54) Chaussures plastiques.

(55)



1.1



1.2



2.1



2.2

(71) SOCIETE K-J PLAST, 15 B.P. 121, ABIDJAN 15 (CI).

(11) **04479**

(21) 4201500060

(22) 14.01.2015

(51) 2

(54) Chaussures plastiques.

(55)



1.1



2.1



3.1



3.2



4.1



4.2

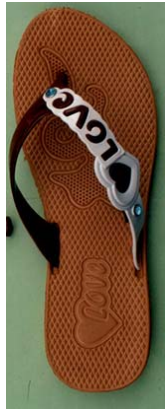

5.1



5.2



6.1



6.2



7.1

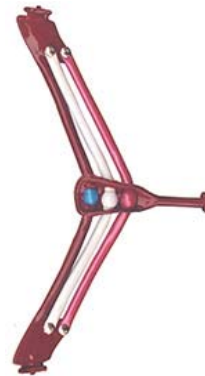

8.1

(71) Ets AT PLAST, 10 B.P. 1889, ABIDJAN 10 (CI).

(11) **04480**

(21) 4201500061

(22) 09.01.2015

(51) 11

(54) Médaillon.

(55)



1.1

(71) OKIERE KOUTOUA, 01 B.P. 12348, ABIDJAN 01 (CI).